

130 Family of Seismic Recorders

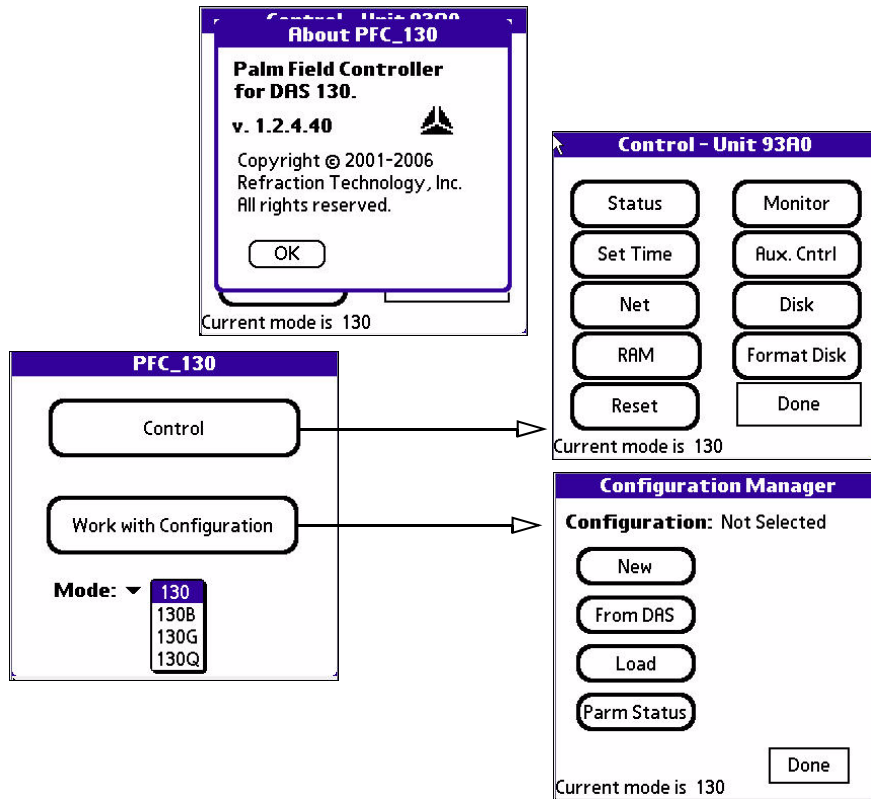

PFC_130 Users Guide (Version 1.2.4.40)

Refraction Technology



Refraction Technology, Inc.

**1600 Tenth Street, Suite A
Plano, Texas 75074
USA**

Voice: 214-440-1265

Fax: 972-578-0045

EMAIL: support@reftek.com

FTP: <ftp.reftek.com>

WWW: <http://reftek.com>

©Copyright 2003-2006 Refraction Technology, Inc.

All rights reserved.

Printed in USA

Preface

All references to a PDA in this guide refer to any type of device that is compatible with the Palm™ operating system (OS) with RS232 (i.e., Palm IIIe™, Palm IIIxe™, Palm V™, Palm VII™, Palm M105™, Handspring Visor™, TRG Pro™, etc.)

REF TEK Support and update notifications

As a valued user of REF TEK equipment we would like to provide the best support possible by keeping you up to date with our product updates.

If you would like to be notified of any REF TEK product updates please spend a couple of minutes to register with the reftek customer support team.

To Register, either send an email to updates@reftek.com giving us your name and REF TEK product you currently have or fill out our online registration form at www.reftek.com/registration

Once we register your contact we will only send necessary notifications via email. The same notifications will be shown on our website's www.reftek.com/support page

Thanks,

Your REF TEK support team

Revision History

Rev	Date	Reason for change	Affected Pages
0.1	1/12/02	Initial release	
A	10/04/02	Release of 1.0 130 Software	Added new triggers supported to Section 1.21 datastream
B	3/25/03	Level trigger table added	Page 1-43
		Sample rate explanation	Page 1-40
		Added aux sensor screens	
	4/30/03	Added Event Trigger Status screens	Section 2.2.4
C	8/27/03	Updated screens and book	Section 2
D	12/09/03	Added Battery charger voltage display	Section 2.2
		Ethernet control option	Section 2.4
		Added Vote Trigger support	Section 3.5.9
E	11/30/04	Added Modem support	Section 2.4
F	09/10/05	Added support for: <ul style="list-style-type: none"> • 130, 130B, 130G and 130Q Modes of operation • Highly Compressed Data Format (C2) • 0.1 Sample Rate • Auxiliary data • Sensor Calibration scheduling 	Section 2 and 3 Separated into two books: For 130B mode For 130, 130G and 130Q Modes
G	12/05/05	Updated template	All
H	2/3/06	Added GPS Duty Cycle option	Section 2.2.2
		Added Dump on ET option to Disk menu	Section 2.9
	4/18/06	Modified Auto-Center Parameter screen	Section 3.8
J	10/17/06	Added RAM Test	Section 2.8.5
		Added Sensor Signal Types: <ul style="list-style-type: none"> • Random-SP • Random-LP • Random-BB • Sweep-SP • Sweep-LP • Sweep-BB 	Section 3.9
K	12/6/06	Added Delay and 1.2.4.40 Updates	All mode screens

Optional Books:

Handbook for the PDA Handheld (PDA OEM)
Getting Started (PDA OEM)

About this manual:

This **REF TEK** manual provides operating instructions for a PDA device that will be used in the field with a DAS. The PDA is an ideal control interface for DAS field setup and operations.

Software Version:

Current software and documentation is available on our web site. Some early units may require hardware modifications to use the latest software. Contact **REF TEK** if you have any queries on the compatibility of your unit(s) and the current software release.

Software Installation:

These instructions assumes the PDA device has never been used and the PDA software has not been installed on a PC, or the battery has been removed the battery for more than one minute and all of the **REF TEK** installed application programs have been erased.

[1] Before upgrade of the PFC_130 application, click the **Menu** icon on the PDA device, select the **App** pull-down, and the **Delete** icon. Click the **PFC_130** and delete. Also click the database file **PFC_CFG_DB** and delete it.

[2] To obtain software updates for the PFC_130:

Use Internet Explorer and enter:
www.reftek.com/downloads.html

Username: Anonymous

Password: Your E-Mail address

Notation Conventions

The following notation conventions are used throughout Ref Tek documentation:

Notation	Description
ASCII	Indicates the entry conforms to the American Standard Code for Information Interchange definition of character (text) information.
Binary	Indicates the entry is a raw, numeric value.
Hex	Indicates hexadecimal notation. This is used with both ASCII characters (0 – 9, A – F) and numeric values.
BCD	Indicates the entry is a numeric value where each four bits represents a decimal digit.
FP n	Indicates the entry is the ASCII representation of a floating-point number with n places following the decimal point.
< n >	Indicates a single 8-bit byte. When the contents are numeric, it indicates a hexadecimal numeric value; i.e. <84> represents hexadecimal 84 (132 decimal). When the contents are capital letters, it represents a named ASCII control character; i.e. <SP> represents a space character, <CR> represents a carriage return character and <LF> represents a line feed character.
MSB	Most Significant Byte of a multi-byte value.
MSbit	Most Significant Bit of a binary number.
LSB	Least Significant Byte of a multi-byte value.
LSbit	Least Significant Bit (bit 0) of a binary number.
YYYY	Year as a 4-digit number
DDD	Day of year
HH	Hour of day in 24-hour format
MM	Minutes of hour
SS	Seconds of minute
TTT	Thousandths of a second (milliseconds)
IIII	Unit ID number
n, nS	nano, nanoSecond; $10^{-9} = 0.000000001$
u, uS	micro, microSecond; $10^{-6} = 0.000001$
m, mS	milli, milliSecond; $10^{-3} = 0.001$
K, KHz	Kilo, KiloHertz; $10^3 = 1,000$
M, MHz	Mega, MegaHertz; $10^6 = 1,000,000$
G, GHz	Giga, GigaHertz; $10^9 = 1,000,000,000$
Kb, KB	Kilobit, KiloByte; $2^{10} = 1,024$
Mb, MB	Megabit, MegaByte; $2^{20} = 1,048,576$
Gb, GB	Gigabit, GigaByte; $2^{30} = 1,073,741,824$

Related Manuals:

130-01 System Documents	Number	PDF file
130-01 System Startup	1301-SYS-001	130_startup_01.pdf
PFC_130 Users Guide	130-PFC-001	130_pfc.pdf
REF TEK Utilities Users Guide	UTILS-OP-002	130_utilities.pdf
Archive Utilities	ARC-OP-003	arcutil.pdf
130 Theory of Operations	130-SYS-002	130_theory.pdf
130 PFC Release Notes	130-RN-001	130_PFCRN.pdf
130 CPU Release Notes	130-RN-002	130_CPURN.pdf
130 RTCC Release Notes	130-RN-003	130_RTCCRN.pdf
130 Command Reference	130-CR-001	130_command.pdf
130 Recording Format	130-RF-001	130_record.pdf
130-GPS/01	130-TR-003	gps01.pdf
130-01 Board Documents	Number	PDF file
RT505 - A/D Board	130-RT505	RT505r.pdf ^a
RT506 - CPU Board	130-RT506	RT506r.pdf
RT520 - Lid Interconnect Board	130-RT520	RT520r.pdf
RT526 - MicroDrive/Flash Board	130-RT526	RT526rB01.pdf
RT527 - Sensor Control Board (Optional)	130-RT527	RT527rB01.pdf
RT535 - Mass Memory Board (Optional)	130-RT535	RT535rB01.pdf
Optional Manuals	Number	PDF file
SNDP Reference Guide	SNDP-S-002	SNDPRef.pdf
SNDP Installation and Users Guide	SNDP-S-003	SNDPUser.pdf
RTPD Installation and Users Guide	RTPD-S-004	RTPD.pdf
RTP Protocol	RTPD-S-004	RTP.pdf
RT_View Users Guide*	RTV-S-005	RTView.pdf
RTCC REF TEK Command and Control Users Guide*	RTCC-S-006	RTCC.pdf
RT_Display Users Guide*	RTD-S-007	RTDisplay.pdf
RTPMonitor Installation and Users Guide	RTPM-S-008	RTPM.pdf
131A-01/3 Standard Triaxial Accelerometer	131A-TR-004	131A.pdf
131A-01/2 Low Noise Triaxial Accelerometer		
131A-01/1 Uniaxial Accelerometer	131A-TR-005	131A011.pdf

a. r = Revision level of 130 Board

* = Programs included in the optional Reftek Command and Control Interface (RTI)

Table of Contents

Section: 1 PFC_130 Users Guide

1.1 Introduction	1-1
1.2 Equipment Supplied	1-2
1.2.1 Hardware	1-2
1.2.2 Software	1-2
1.3 Quickstart	1-3
1.3.1 REF TEK Applications - PFC_130	1-3
1.3.2 Toggling Between Applications	1-3
1.3.3 Setup	1-3
1.4 Start the PFC_130 Application	1-4

Section: 2 Control Screens

2.1 Using the <i>Control</i> menu.	2-7
2.2 Using the <i>Status</i> menu	2-8
2.2.1 Start and Stop Acquisition	2-9
2.2.2 GPS status button	2-10
2.2.3 Net status	2-11
2.2.4 Event Trigger Status	2-12
2.2.5 Version status	2-14
2.3 Using the <i>Set Time</i> button.	2-16
2.4 Using the <i>Net Setup</i> screen.	2-17
2.4.1 Assign ethernet parameters	2-17
2.4.2 Assign Serial PPP parameters	2-20
2.5 Using the <i>RAM</i> button	2-23
2.6 Using the <i>Reset</i> button	2-25
2.7 Using the <i>Monitor</i> function	2-26
2.8 Using the <i>Auxiliary Control</i> button	2-28
2.8.1 Using the Offset Option	2-29
2.8.2 Using the ANSS Test	2-31
2.8.3 Generating a sensor test signal	2-31
2.8.4 Aux Channels	2-32
2.8.5 RAM Test	2-33
2.9 Using the <i>Disk</i> parameter button	2-34
2.10 Using the <i>Format Disk</i> button	2-36
2.11 When the Control Menu does not display	2-37

Section: 3 Configuration Screens

3.1 Using the <i>Configuration</i> Manager Menu	3-39
3.1.1 Using the Configuration manager menu	3-39
3.2 Configure the DAS for new parameters	3-41
3.3 Edit configurations	3-42
3.4 Activate a channel	3-43
3.4.1 Add channel details	3-44
3.4.2 Deactivate a channel	3-47
3.5 Define datastreams	3-48
3.5.1 Add stream data details	3-49
3.5.2 Configure a Continuous Trigger (CON)	3-52
3.5.3 Configure a Level Trigger (LEV)	3-54
3.5.4 Configure a Cross Trigger (CRS)	3-57
3.5.5 Configure an Event Trigger (EVT)	3-59
3.5.6 Configure an External Trigger (EXT)	3-62
3.5.7 Configure a Time Interval Trigger (TIM)	3-63
3.5.8 Configure a Time List Trigger (TML)	3-66
3.5.9 Configure a Vote Trigger (VOT)	3-68
3.5.10 Deactivate a datastream	3-71
3.6 130 Auxiliary Data	3-72
3.7 130-GSN Auxiliary Data	3-74
3.8 Auto Re-center sensors	3-77
3.9 Sensor Test	3-78
3.9.1 Step Signal Type	3-80
3.9.2 Sine Signal Type	3-82
3.9.3 Random Signal Type	3-83
3.9.4 Random-SP Signal Type	3-84
3.9.5 To schedule sensor tests	3-90
3.10 Save or delete configurations	3-93
3.11 Load a saved configuration	3-94
3.12 Check parameter status	3-95
3.13 Send a configuration to the DAS	3-96
3.14 From DAS	3-97
3.15 Appendix A: Software installation	3-98

List of Figures

PFC_130 Users Guide

Figure 1 - 1	Refttek Category - PFC_130	1-3
Figure 1 - 2	Options menu - display version	1-4
Figure 1 - 3	Main PFC_130 menu with About PFC_130	1-4
Figure 1 - 4	PFC_130 Modes of operation	1-5

Control Screens

Figure 2 - 1	Connect initialization menu - Get Unit ID	2-7
Figure 2 - 2	Load parameters for Status menu	2-8
Figure 2 - 3	Load acquisition, Unit and Time status	2-8
Figure 2 - 4	Updated Status screen	2-8
Figure 2 - 5	Confirm Acquisition	2-9
Figure 2 - 6	Stop Acquisition	2-9
Figure 2 - 7	GPS Status connection screens	2-10
Figure 2 - 8	GPS Status and Update	2-10
Figure 2 - 9	GPS Duty Cycle options	2-11
Figure 2 - 10	NET RTP Serial and Ethernet status screens	2-11
Figure 2 - 11	Event trigger status	2-12
Figure 2 - 12	Event trigger status - Stream drop-down	2-12
Figure 2 - 13	Event trigger status - Channel drop-down	2-12
Figure 2 - 14	Update Event Trigger Status	2-13
Figure 2 - 15	Version status screens	2-14
Figure 2 - 16	CPU Code version and board information	2-14
Figure 2 - 17	Drop-down board screen and board information	2-14
Figure 2 - 18	Board Info for CPU and ATD (Analog to Digital) boards	2-15
Figure 2 - 19	Version screen and sensor information	2-15
Figure 2 - 20	Sensor info screen	2-15
Figure 2 - 21	Set Time screens	2-16
Figure 2 - 22	Set Date menu	2-16
Figure 2 - 23	Get network information	2-17
Figure 2 - 24	Assign network parameters	2-17
Figure 2 - 25	Setting Ethernet parameters (Line Down) (Toss)	2-18
Figure 2 - 26	Toss After minutes and Ethernet Control options	2-19
Figure 2 - 27	Sending parameters	2-19
Figure 2 - 28	Assign Serial PPP parameters and Line Down	2-20
Figure 2 - 29	Line Down - Keep/Toss parameter	2-20
Figure 2 - 30	Assign Serial PPP Line Mode and Baud Rate	2-21
Figure 2 - 31	Send Serial PPP parameters to the DAS	2-21
Figure 2 - 32	Send Serial PPP parameters	2-21
Figure 2 - 33	Modem setup screen	2-22
Figure 2 - 34	Modem Init string	2-22
Figure 2 - 35	Send the modem parameters	2-22
Figure 2 - 36	RAM commands	2-23
Figure 2 - 37	Clear RAM display	2-23
Figure 2 - 38	Update RAM status	2-24
Figure 2 - 39	Dump option	2-24

Figure 2 - 40	Reset the DAS	2-25
Figure 2 - 41	Monitor function display	2-26
Figure 2 - 42	Display monitor command results	2-26
Figure 2 - 43	Monitor update button sequence	2-27
Figure 2 - 44	Test options - Aux. Cntrl	2-28
Figure 2 - 45	Offset settings screen	2-29
Figure 2 - 46	Calculating Offset	2-29
Figure 2 - 47	Store the offset and display the results	2-30
Figure 2 - 48	Store the offset value	2-30
Figure 2 - 49	Send the internal accelerometer a test signal	2-31
Figure 2 - 50	On-demand test sensor (ch 1-3)	2-31
Figure 2 - 51	On-demand test sensor (ch 4-6)	2-32
Figure 2 - 52	Aux Channels	2-32
Figure 2 - 53	Aux Control - RAM Test	2-33
Figure 2 - 54	Set the Disk Dump Threshold and Dump the Disk	2-34
Figure 2 - 55	Auto wrap option	2-34
Figure 2 - 56	Dump on ET Option	2-35
Figure 2 - 57	Send the dump threshold	2-35
Figure 2 - 58	Format drop-down menu	2-36
Figure 2 - 59	Get Unit ID display	2-37
Figure 2 - 60	Error in connection display	2-37

Configuration Screens

Figure 3 - 1	PFC_130 Main menu	3-39
Figure 3 - 2	Configuration Manager menu	3-40
Figure 3 - 3	Configuration menu without configuration	3-41
Figure 3 - 4	Adding a new parameter (configuration) name	3-41
Figure 3 - 5	Edit or add parameters sub menu	3-42
Figure 3 - 6	Edit Configuration menu	3-42
Figure 3 - 7	Experiment	3-42
Figure 3 - 8	Channel submenu	3-43
Figure 3 - 9	Activate channel submenu	3-43
Figure 3 - 10	Channel details - Parameter entry	3-44
Figure 3 - 11	Channel name	3-44
Figure 3 - 12	Adding Channel comments	3-44
Figure 3 - 13	Enter the sensor model and serial number	3-45
Figure 3 - 14	Channel Details	3-46
Figure 3 - 15	Deactivate a channel	3-47
Figure 3 - 16	Return to the Edit Configuration from Channels	3-47
Figure 3 - 17	Configuration Menu (Edit Streams)	3-48
Figure 3 - 18	Activate Datastreams	3-48
Figure 3 - 19	Stream Details- Parameter entry	3-49
Figure 3 - 20	Stream Details - Channel check-off	3-49
Figure 3 - 21	Set datastream format	3-49
Figure 3 - 22	Set datastream sample rate	3-50
Figure 3 - 23	Trigger type selection	3-51
Figure 3 - 24	Continuous Trigger submenu	3-52

List of Figures

Figure 3 - 25	Set Date & Time submenu	3-52
Figure 3 - 26	Set time	3-53
Figure 3 - 27	Continuous streams details	3-53
Figure 3 - 28	Level Trigger submenu	3-54
Figure 3 - 29	Level Trigger submenu	3-55
Figure 3 - 30	Level trigger Hi-Pass	3-55
Figure 3 - 31	Level trigger Low-Pass	3-56
Figure 3 - 32	Opening Cross Trigger submenu	3-57
Figure 3 - 33	Cross trigger record length submenu	3-57
Figure 3 - 34	Closing Cross Trigger submenu	3-58
Figure 3 - 35	Event Trigger submenu	3-59
Figure 3 - 36	Event Trigger submenu and Channels	3-60
Figure 3 - 37	STA and LTA	3-60
Figure 3 - 38	Event trigger Hi-Pass	3-61
Figure 3 - 39	Event trigger Low-Pass	3-61
Figure 3 - 40	External Trigger submenu	3-62
Figure 3 - 41	External trigger settings	3-62
Figure 3 - 42	Stream Details to Datastreams	3-63
Figure 3 - 43	Time Trigger submenu	3-63
Figure 3 - 44	Set date and time	3-64
Figure 3 - 45	Time Trigger intervals and record length	3-64
Figure 3 - 46	Completed Stream Details for Time Trigger	3-65
Figure 3 - 47	Time List Trigger submenu	3-66
Figure 3 - 48	Set date and time	3-66
Figure 3 - 49	Set Time and Completed Start Time List	3-67
Figure 3 - 50	Time List stream details	3-67
Figure 3 - 51	Vote Trigger submenu	3-69
Figure 3 - 52	Trigger Levels/Votes submenu	3-69
Figure 3 - 53	De-Trigger Levels/Votes submenu	3-70
Figure 3 - 54	Set Hi-Pass filter	3-70
Figure 3 - 55	Set Hi-Pass filter	3-70
Figure 3 - 56	Deactivate a datastream	3-71
Figure 3 - 57	Auxiliary Data Channels	3-72
Figure 3 - 58	Aux Data - Sample Period	3-73
Figure 3 - 59	Aux Data - Record Length	3-73
Figure 3 - 60	Auxiliary Data Channels	3-74
Figure 3 - 61	Aux Data destination	3-74
Figure 3 - 62	Aux Data - Differential	3-75
Figure 3 - 63	Aux Data - Sample Period	3-75
Figure 3 - 64	Aux Data - Record Length3	3-76
Figure 3 - 65	Auto Center configuration	3-77
Figure 3 - 66	Auto Center - Enable	3-77
Figure 3 - 67	Sensor calibration signal	3-78
Figure 3 - 68	Sensor Test - Channel group	3-78
Figure 3 - 69	Sensor test channel and enable	3-78
Figure 3 - 70	Signal type pull-down	3-79
Figure 3 - 71	Sensor Test parameters	3-81

Figure 3 - 72	Sine Signal Type	3-82
Figure 3 - 73	Sine Signal Frequency	3-82
Figure 3 - 74	Random Signal Type	3-83
Figure 3 - 75	Random-SP Signal Type	3-84
Figure 3 - 76	Random-SP Duration	3-84
Figure 3 - 77	Random-LP Signal Type	3-85
Figure 3 - 78	Random-LP Duration	3-85
Figure 3 - 79	Random-BB Signal Type	3-86
Figure 3 - 80	Random-BB Duration	3-86
Figure 3 - 81	Sweep-SP Signal Type	3-87
Figure 3 - 82	Sweep-SP	3-87
Figure 3 - 83	Sweep-LP Signal Type	3-88
Figure 3 - 84	Sweep-LP	3-88
Figure 3 - 85	Sweep-BB Signal Type	3-89
Figure 3 - 86	Sweep-BB Amplitude	3-89
Figure 3 - 87	Schedule button	3-90
Figure 3 - 88	Set Schedule Start Time	3-91
Figure 3 - 89	Set Calibration Repeat Interval	3-91
Figure 3 - 90	Number of Calibrations	3-92
Figure 3 - 91	Save configuration	3-93
Figure 3 - 92	Saved As - configuration	3-93
Figure 3 - 93	Load a saved configuration	3-94
Figure 3 - 94	Loading a saved configuration	3-94
Figure 3 - 95	Param Status button	3-95
Figure 3 - 96	Send a configuration to the DAS	3-96
Figure 3 - 97	Get configuration from DAS	3-97
Figure 3 - 98	Hotsync menu	3-98
Figure 3 - 99	Custom Hotsync options	3-99
Figure 3 - 100	Install PFC	3-99
Figure 3 - 101	PFC file added	3-99
Figure 3 - 102	Approve installation during HotSync	3-100
Figure 3 - 103	HotSync process	3-100



Section 1

PFC_130 Users Guide

1.1 Introduction

This manual provides operating instructions for a PDA device with the **PFC_130** software that will be used in the field with a DAS. A PDA is an ideal control interface for DAS field setup and operations.

If your PDA device was shipped from **REF TEK** it has been pre-configured. All you will need to do is install the PDA operating system on your local PC (reference the *PDA Handbook* for instructions). Once you perform an initial hotsync your PC will be synchronized with the required **REF TEK** applications. From this point, should your PDA device or PC require a restore, you can perform a hotsync to restore the **REF TEK** applications. If for some reason you need to perform a complete restore or your device was **not** supplied by **REF TEK**, reference "Appendix A: Software installation" on page 3-85 of this manual for a complete software installation procedure.



Note: It is very important to reference the **Battery Considerations in the PDA handbook** for a complete understanding of the battery life cycle. There are certain conditions that may occur that will require a complete software installation (reference "Appendix A: Software installation" on page 3-85).

This guide includes the following topics:

- Quick start - a simple test setup to verify communication between the DAS and the PDA device.
- Control operations using the PDA Field Controller (**PFC_130**) program for the DAS.
- Changing serial port configuration using the **PFC_130** program for the DAS.
- Managing parameters.

1.2 Equipment Supplied

REF TEK supplies the following equipment to use the PDA device as the control interface for a DAS:

1.2.1 Hardware

1. PDA with PDA documentation.
2. **REF TEK** Adapter Cables:

Cable	Part Number
Custom DB9 to 130 Command	130-8017
Command and Control	130-8025
CLIE™ Command and Control	130-8103
Ruggedized Palm cable	130-8260

1.2.2 Software

1. PDA Desktop Organizer Software (OEM)
2. **REF TEK** - PDA Application (**PFC_130**)*

WARNING: Refer to Appendix A to install the PFC_130 application. With version 2.4 be sure to erase the saved configurations by using the Delete menu on the PDA device to delete the PFC_130_CFG.DB file.

1.3 Quickstart

1.3.1 REF TEK Applications - PFC_130

This section provides instructions to perform a simple communication verification between your PDA device and a DAS unit.

Prior to getting started you will want to familiarize yourself with the **REF TEK** applications that have been supplied with your device. The **REF TEK** category contains the **PFC_130** application that will:

1. Perform DAS control operations.
2. Create parameter records that are required for your particular experiment.

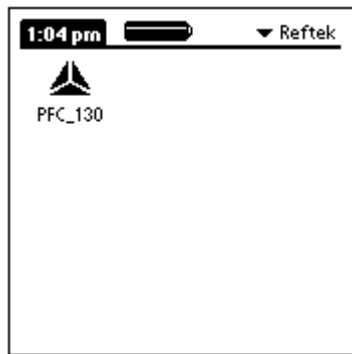

Figure 1 - 1 Reftek Category - PFC_130

1.3.2 Toggling Between Applications

To get to the **REF TEK** applications, select the *Applications* menu:

1. Select the icon button on your PDA.
2. Select **Reftek** and the application icon **PFC_130** will appear for your selection on the screen as in Figure 1 - 1.

1.3.3 Setup

1. Connect the appropriate **REF TEK** supplied serial cable (PN 130-8260) (PN 130-8025 - if PDA is from **REF TEK**) or (PN 130-8103 - if CLIE™ PDA is from **REF TEK**) to your PDA adapter cable (refer to the cable drawings in the *130 System Startup*).
2. Mate the PDA adapter cable to the port on the PDA device.
3. Connect the appropriate **REF TEK** cable to the SERIAL port on the 130 unit.

1.4 Start the PFC_130 Application

1. Select the **PFC_130** icon in the display window to launch the application.

The title screen with the version will open in the display (See Figure 1 - 2).



Figure 1 - 2 Options menu - display version

2. The main **PFC_130** menu will open in the window (as in Figure 1 - 3).
3. To check the PDA version of PFC_130 select the **Options** pull-down menu and the **About PFC_130** at the top of the display (See Figure 1 - 3).

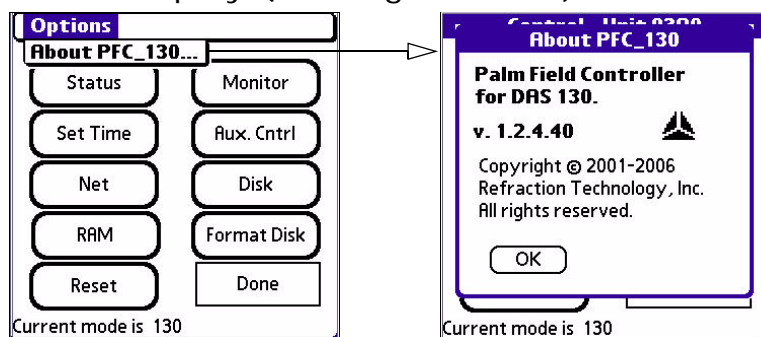
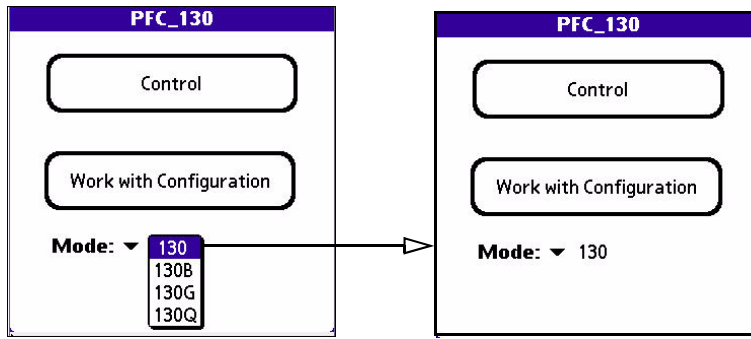

Figure 1 - 3 Main PFC_130 menu with About PFC_130

- Use the **Mode** pull-down menu to select the mode of operation used by your DAS

The following options are available: .



Mode	Description
130	Standard 130 unit with channel 1-3 settings and settings for optional channels 4-6 along with optional RT527 SCB setup screens.
130B	130B unit without channel gain options. No channels 4-6 options.
130G	130-GSN version with channels 1-6, RT527 SCB and Auxiliary channels 1-16 options.
130Q	130Q unit with RT566 A/D. Provides options for extra gain and filter stages associated with the RT566 A/D board.

Figure 1 - 4 PFC_130 Modes of operation



Section 2 Control Screens

2.1 Using the Control menu



Note: If the desired mode of operation is for use with the 130B use the *PFC_130B User Guide*. The *PFC_130 Users Guide* includes the 130, 130G, and 130Q versions of PFC_130.

1. After choosing the desired mode of operation, click the **Control** menu and initialize a connection with the DAS

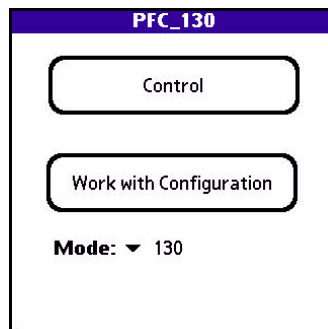

2. A **Connect to DAS** menu (Figure 2 - 1) will display initializing the connection to the DAS.

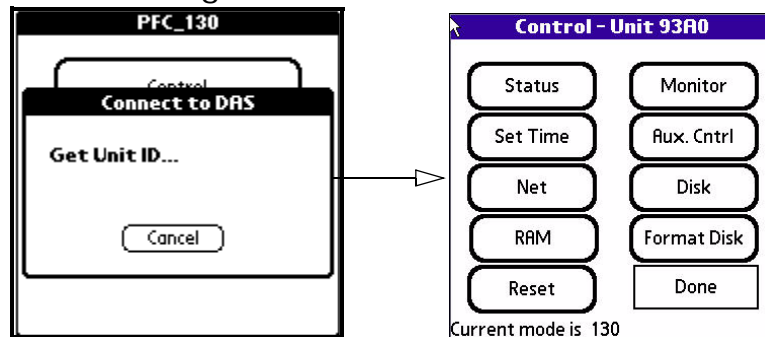

Figure 2 - 1 Connect initialization menu - Get Unit ID

3. The **Control** menu will display when a connection is established. Refer to the section "When the Control Menu does not display" on page 2-37, if this screen does not display.

2.2 Using the *Status* menu

1. After establishing connection, click the **Status** button from the **Control** menu as shown in Figure 2 - 2, and check the station status after updates are loaded.

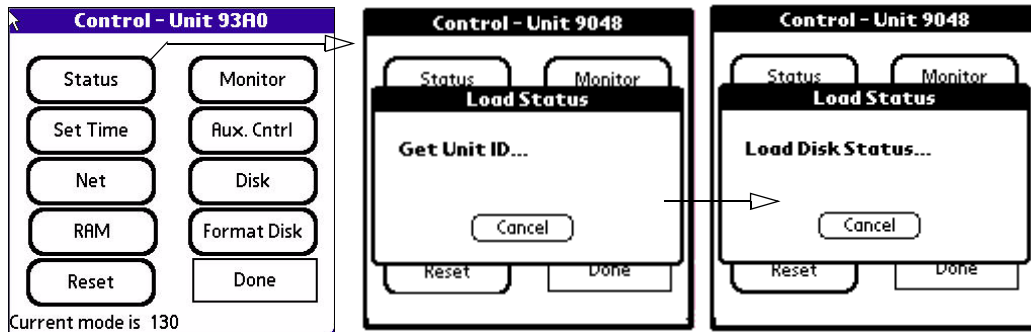

Figure 2 - 2 Load parameters for Status menu

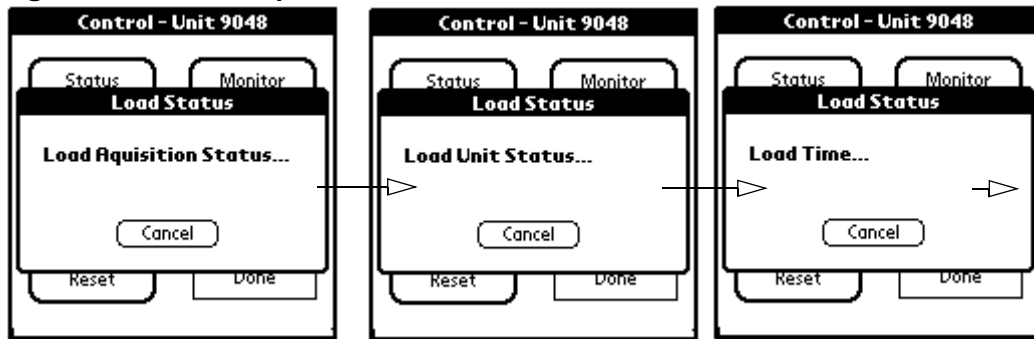

Figure 2 - 3 Load acquisition, Unit and Time status

Acq status

- Start ON = Acquisition start requested and acquisition is ON
- Start OFF = Acquisition start requested and acquisition is OFF
- Stop ON = Acquisition stop requested and acquisition is ON
- Stop OFF = Acquisition stop requested and acquisition is OFF

Net status

GPS status

Status - Unit 9005

Time: 2003:343:21:06:39

Acq: Stop OFF Start Acq.

Events: 0

RAM: 3 of 4864 Kb

Disk1: not installed

Disk2: not installed

Temperature: +28.9C

Power: 12.3in, 03.3bkr, 00.0chgr V

Ch: ----- DS: -----

GPS Net Event

Update Version Done

Version information

Request DAS status and update display

DAS time

Start Acquisition button

Event number

RAM status (Used of available)

Disk 1 Status (Used of available)

Disk 2 Status

Main input voltage

Backup battery voltage, Battery Charger voltage*

Active Channels (1-6), Active Datastreams, and trigger types

Event Trigger Status

C = Continuous

I = Time Interval

E = Event

L = Level

T = Time List

K = Cross

X = External

V = Vote

*Note: Battery Charger voltage ONLY applies to 130-SM DAS Units
On all other DAS units it will show "00.0chgr V"

Figure 2 - 4 Updated Status screen

2.2.1 Start and Stop Acquisition

To turn acquisition on or off click the Start Acq button

1. Click **Start Acq** next to the Acquisition line on the **Status-Unit** menu.
2. If a delay before acquisition is needed, enter a delay time and approve with the **OK** button.

-OR-

To approve the acquisition to start immediately select the **OK** button.

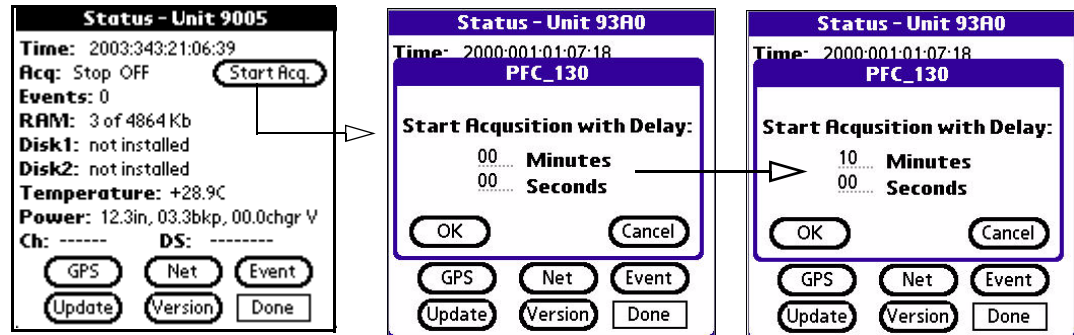

Figure 2 - 5 Confirm Acquisition



3. Confirm Stop Acquisition by selecting the **OK** button.

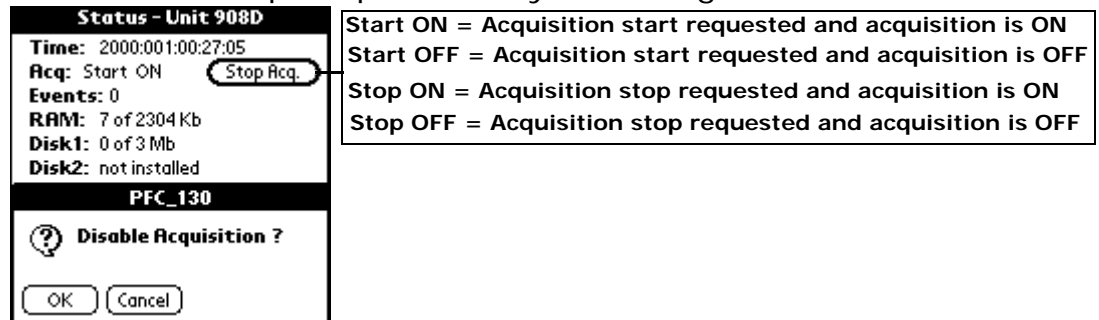

Figure 2 - 6 Stop Acquisition



Note: To disable acquisition click the *Stop Acq* button when Acquisition says 'ON'

2.2.2 GPS status button

To check the status of the GPS:

1. Click the **GPS** button to check the GPS status.

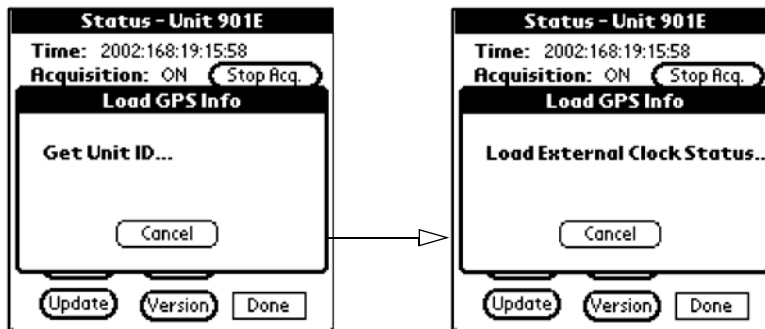

Figure 2 - 7 GPS Status connection screens

2. Click the **Update** button to update the GPS display.

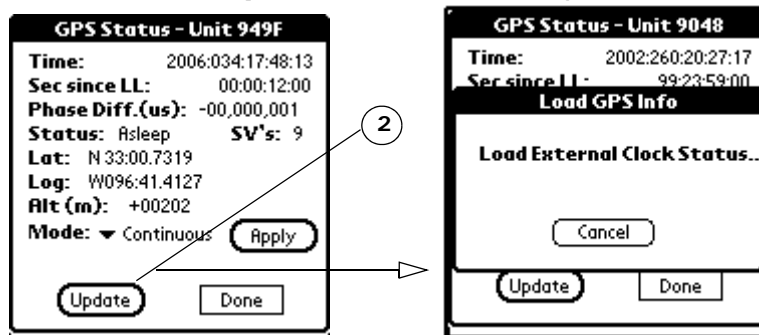

Figure 2 - 8 GPS Status and Update

To set the GPS Mode for how the GPS will be used to phase lock the internal VCXO:

3. Select one of the options, as described below, from the **Mode** drop-down menu

Mode Option	Description
Before CPU firmware version 2.7.3	Hard coded as Cycled
After 2.7.3	
Continuous	The GPS is never turned OFF and the 130 performs its GPS wake cycles continuously.
Cycled	After the first GPS wake cycle, the GPS is powered OFF for 20 minutes. The GPS is then powered ON for one wake cycle and then powered OFF for 20 minutes again. The 130 repeats the 20 minutes OFF and ON for 1 GPS wake cycle while in the Duty-Cycle mode.
OFF	The 130 will turn the GPS ON for the first GPS wake cycle. After the first GPS wake cycle, the GPS is powered OFF and never powered ON again.

4. Select the **Apply** button to accept the **Mode** option.

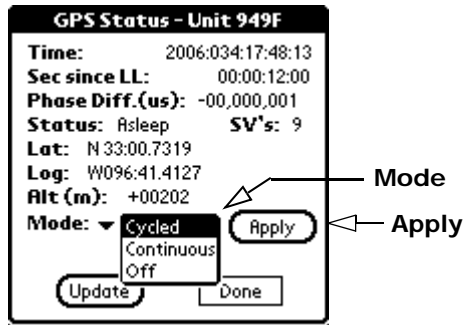
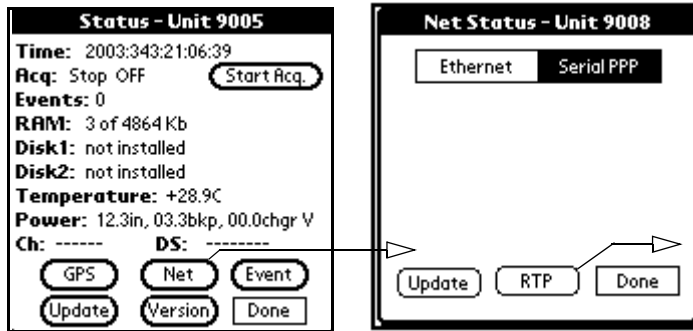

Figure 2 - 9 GPS Duty Cycle options

2.2.3 Net status

1. To check the NET status click the **Net** option from the Status screen.



2. Click the **RTP** option to display Ethernet or Serial RTP status screens.

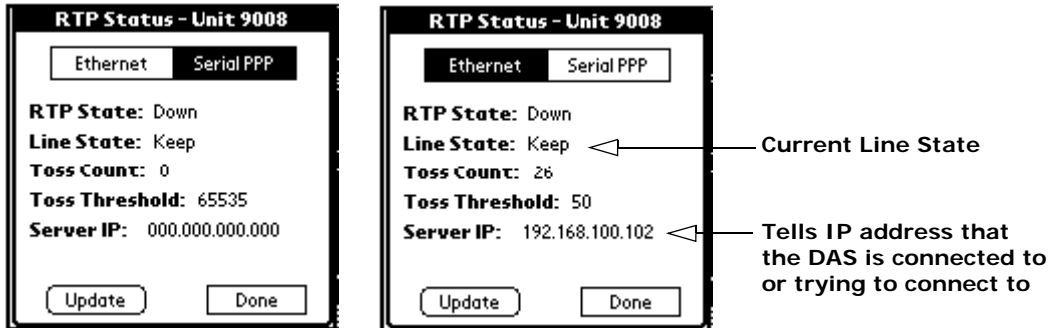

Figure 2 - 10 NET RTP Serial and Ethernet status screens

2.2.4 Event Trigger Status

To check the Event Trigger status:

1. Click the **Event** option from the Status screen.

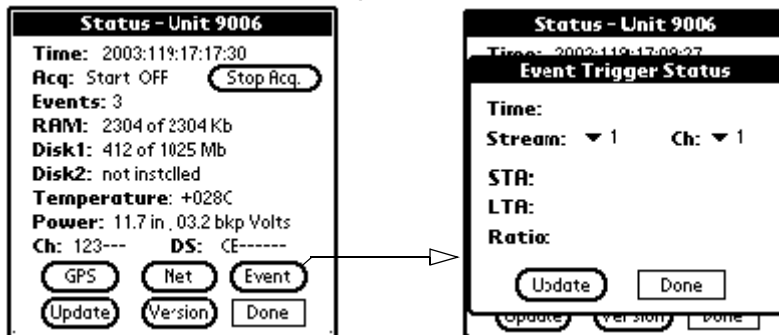

Figure 2 - 11 Event trigger status

2. Click the desired **Stream** from the drop-down list to display the status for that datastream.

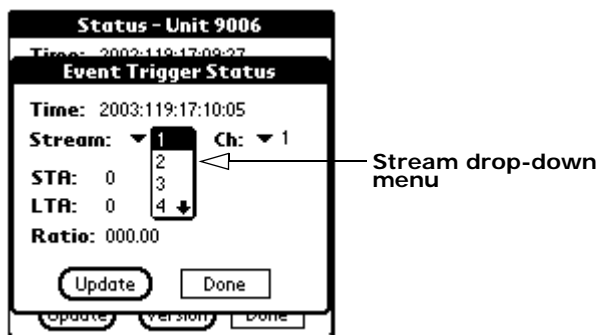

Figure 2 - 12 Event trigger status - Stream drop-down

3. Click the desired **Channel** from the drop-down list to display the status for the selected channel.

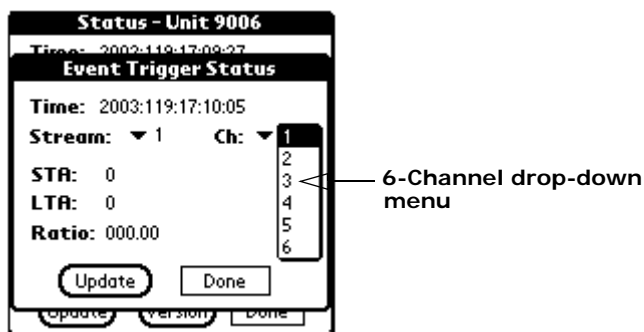

Figure 2 - 13 Event trigger status - Channel drop-down

- Click the **Update** button to update the display with status information.

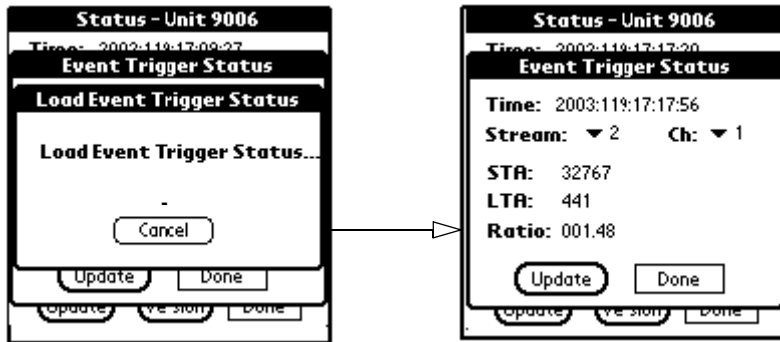

Figure 2 - 14 Update Event Trigger Status

The Event trigger specifies that data will be recorded when the ratio between the Short Term Average (STA) and the Long Term Average (LTA) of the filtered digital data exceeds a specified ratio for a minimum number of trigger channels. An event trigger requires the DAS to perform complex calculations on the data. The DAS uses each sample from a trigger channel to calculate a short term average (**STA**) and a long term average (**LTA**). See Chapter 4, "Event Trigger" on page 4-29 of the *Theory of Operations* for more detailed information.

2.2.5 Version status

To check version information:

1. Click the **Version** button to check the version of CPU firmware code, board count, information about boards and the sensor information.

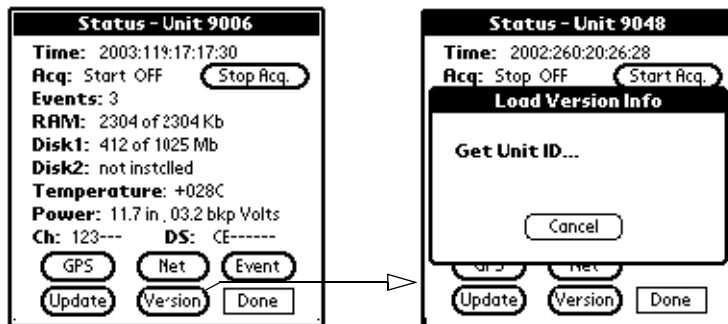

Figure 2 - 15 Version status screens

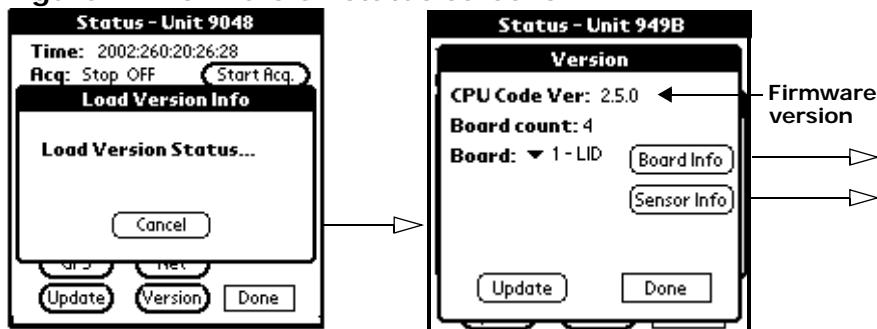

Figure 2 - 16 CPU Code version and board information

2. Click the **Board Info** button to view a selected board's hardware information.

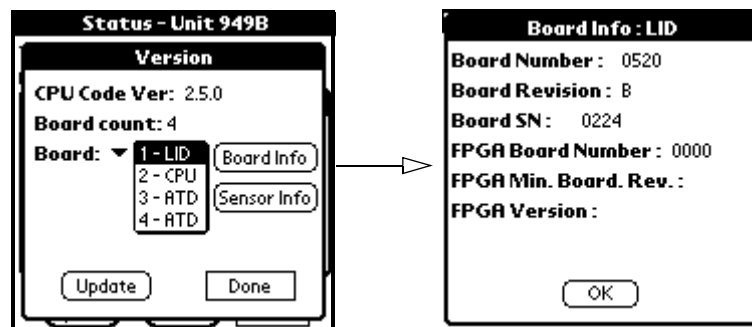

Figure 2 - 17 Drop-down board screen and board information

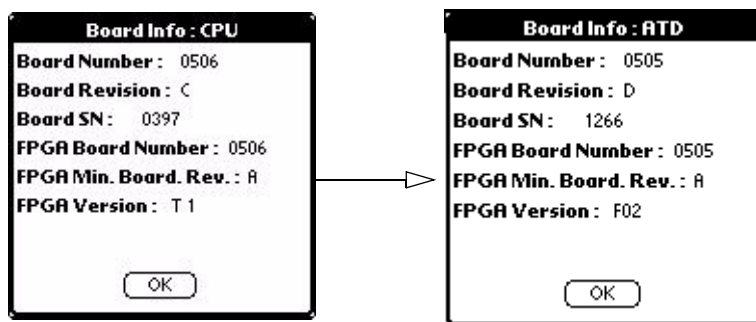

Figure 2 - 18 Board Info for CPU and ATD (Analog to Digital) boards

3. Click the **Sensor Info** button to check the sensor information.

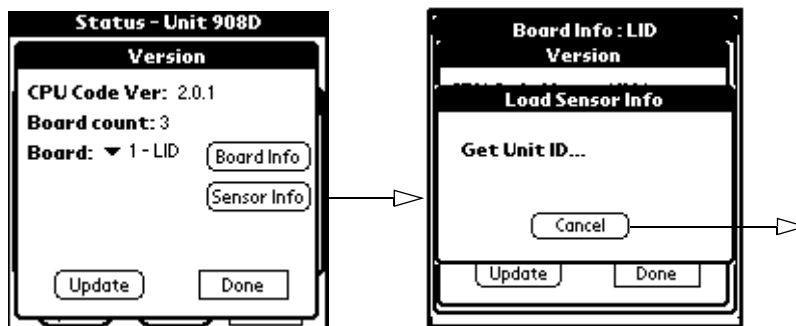

Figure 2 - 19 Version screen and sensor information

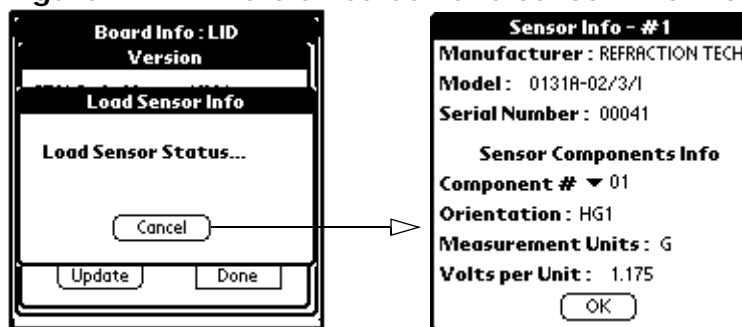

Figure 2 - 20 Sensor info screen



Note: Sensor info displays sensor information for sensors with 1-wire EPROMS attached. This includes 130 recorders w/internal accelerometers and 131A external accelerometers when the RT527 sensor control board is installed.

4. Click the **OK** button to return to the **Status** button.
5. To update the **Status** display use the **Update** button as in Figure 2 - 8 on page 2-10.

2.3 Using the *Set Time* button

To set the time:

1. Click the **Set Time** button to bring up the **Set Time** window:

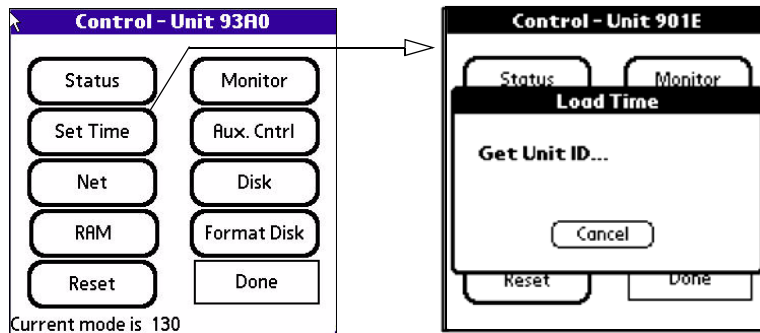
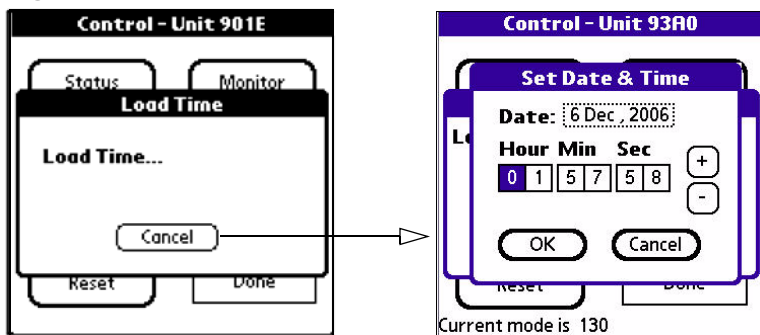

Figure 2 - 21 Set Time screens



2. Click the **Date** window and another display opens to set the date.

Set the date and click **OK** on the Set Date and Time to return to the **Control** menu.

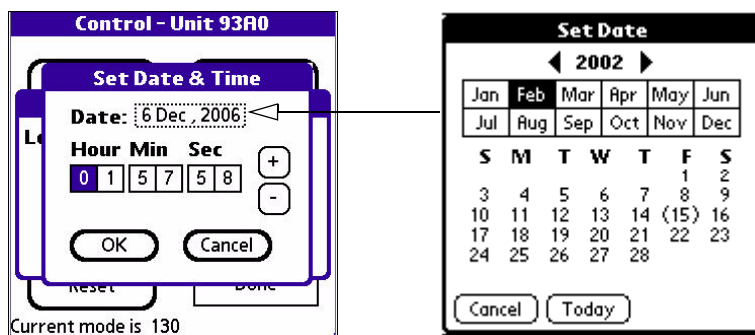

Figure 2 - 22 Set Date menu

2.4 Using the Net Setup screen

2.4.1 Assign ethernet parameters

A 130 DAS is shipped pre-configured with a default IP address. Be sure to change this address before connecting to an ethernet port.

1. Once connection is established, click the **Net** button from the **Control** menu and assign Ethernet parameters (IP address, etc) (See Figure 2 - 24).

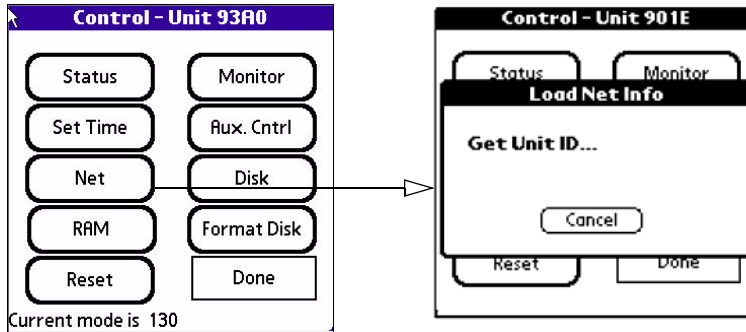

Figure 2 - 23 Get network information

2. Highlight the **Ethernet** window to assign parameters.

WARNING: DO NOT assign both Serial PPP and Ethernet addresses on the same subnet

Click each line item to enter information.
Verify the entries for each setting are correct.

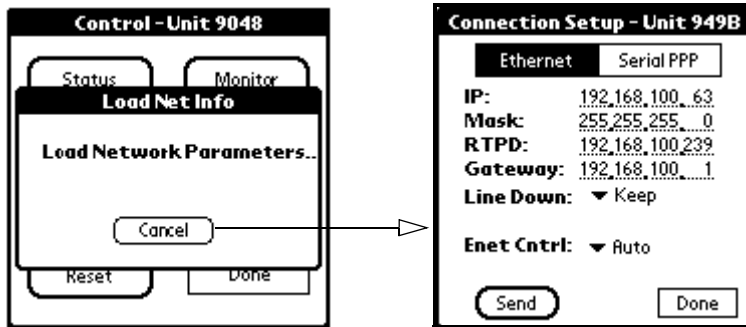

Figure 2 - 24 Assign network parameters



Note: Any IP addresses on one of the same subnets, as the 130 DAS unit, may connect using FTP and/or the command socket. However, the 130 DAS unit restricts the external IP addresses from which it will accept connections, to the equivalent of a Class C subnet containing the RTP host. If no RTP host is set for an interface, no connections can be established to the unit from outside its subnet.

- Click the **Line Down** menu to select an option from the pull-down.



Note: *Line Down* refers to the connection status when the line is down.

- If the connection is down the *Keep* parameter will allow old data to backup in RAM and be transmitted first when the connection is re-established. The RAM may fill in this case and stop acquisition.
- If the connection is down, the *Toss* parameter will throw away old data after the specified time (2 to 99 minutes), until the connection is re-established. Consideration should be taken to adjust the toss time according to the sample rate so that the toss delay expires before the RAM fills causing acquisition to stop.

Click the **Line Down** option **Toss**.

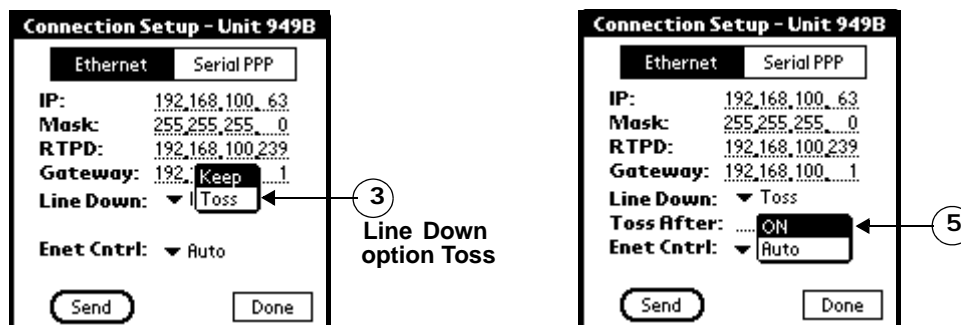

Figure 2 - 25 Setting Ethernet parameters (Line Down) (Toss)

- Enter the **Toss After** minute value by selecting the line next to **Min**.
- Select the Ethernet Control option from the **Enet Cntrl** drop-down menu.



Note: The Ethernet circuitry in the 130 includes the ability to detect when the Ethernet port is connected to other network equipment, such as hubs and routers. When the circuitry indicates the lack of a connection, the firmware puts the Ethernet chip into a low power state.

- When ON is selected the Ethernet Detection option is used to force the Ethernet circuitry to remain powered up so that communications can occur.
- When Auto is selected an attempt is made to connect if the 130 detects that it is connected to network equipment. However some 100 Mbit network equipment cannot be detected by the circuitry in the 130, so the ON option should be used for 130's that are to be permanently connected to Ethernet network equipment.

- Verify the cable connection for the NET connection and that the Serial PPP Connection Setup Host address is also "zero-ed" out before starting acquisition.

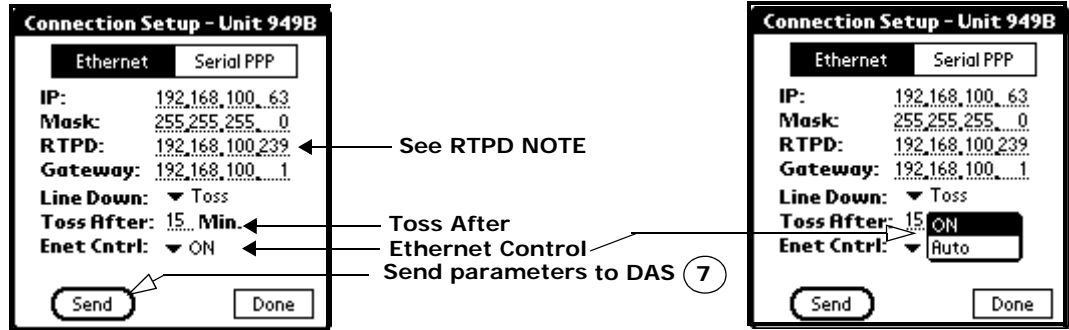

Figure 2 - 26 Toss After minutes and Ethernet Control options

- Click the **Send** button to send the Ethernet parameters to the DAS.



Note: The "Send" button sends both the Ethernet and Serial PPP parameters to the 130 at the same time.

Note: RTPD: If the Serial PPP RTPD address is set this will always be used as the RTPD host for Server Discovery.

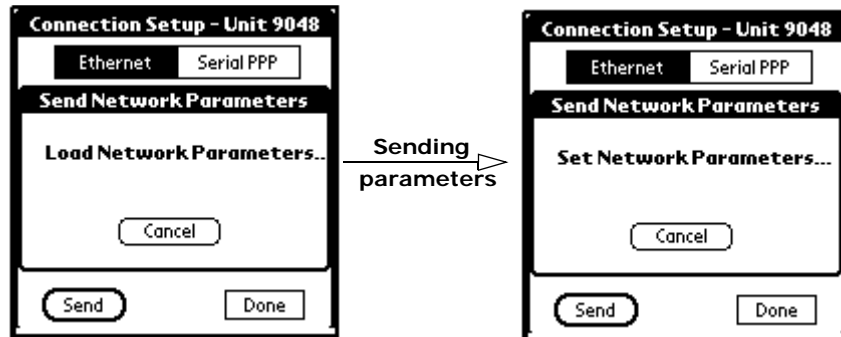

Figure 2 - 27 Sending parameters

2.4.2 Assign Serial PPP parameters

1. Highlight the **Serial PPP** window and assign Serial PPP parameters.

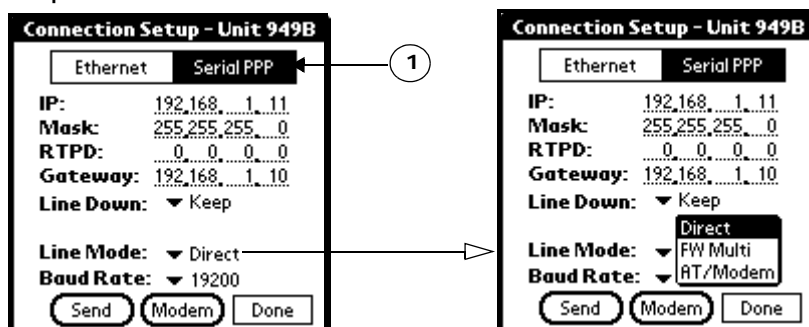

Figure 2 - 28 Assign Serial PPP parameters and Line Down

WARNING: DO NOT assign both Serial PPP and Ethernet addresses on the same subnet

WARNING: Click each line item to enter information

2. Click the **Line Down** pull-down arrow and enter the option.

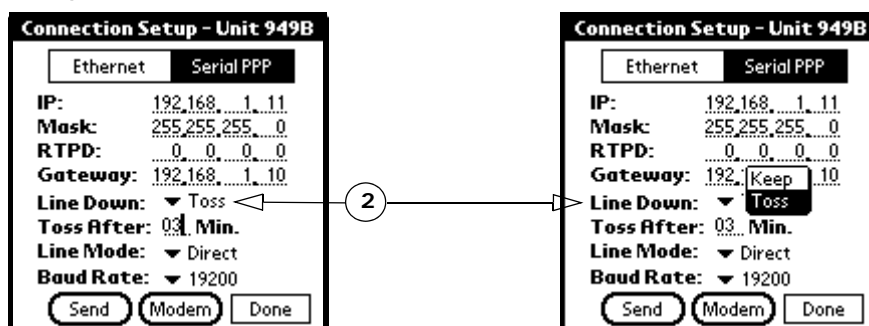

Figure 2 - 29 Line Down - Keep/Toss parameter

Note: Line Down refers to the connection status when the line is down.



- [1] If the connection is down the *Keep* parameter will allow old data to backup in RAM and be transmitted first when the connection is re-established. The RAM may fill in this case and stop acquisition.
- [2] If the connection is down, the *Toss* parameter will throw away old data after the specified time (2 to 99 minutes), until the connection is re-established. Consideration should be taken to adjust the toss time according to the sample rate so that the toss delay expires before the RAM fills causing acquisition to stop.

- Click the **Line Mode** (type of serial connection) pull-down arrow and select an option from the pull-down.



Note: Direct - Connection to a PC or router or FW in point-to-point mode.

Note: FW Multi - Connection to a Freewave operating in multipoint mode.

Note: AT/Modem - Connection to a modem.

- Click the **Baud Rate** (serial port speed) pull-down arrow and select the baud rate.

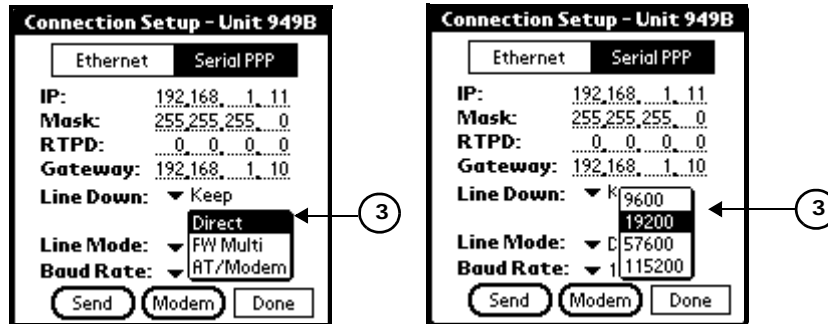

Figure 2 - 30 Assign Serial PPP Line Mode and Baud Rate

- After assigning Serial PPP parameters use the **Send** button to send them to the DAS.

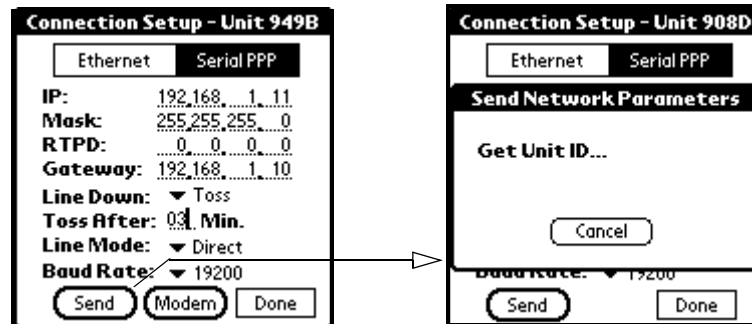
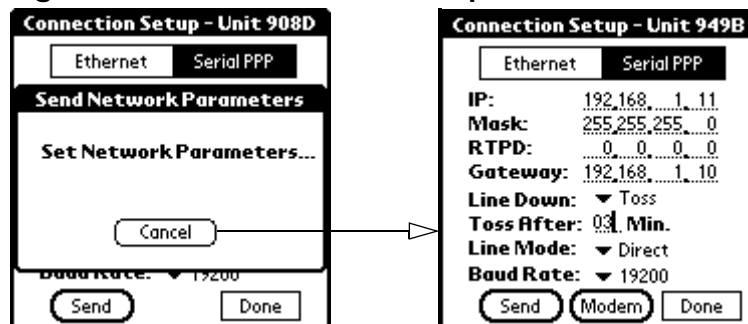

Figure 2 - 31 Send Serial PPP parameters to the DAS



Note: When the Send button is selected both Ethernet and Serial PPP IP configuration are sent to the DAS at the same time. So it is therefore possible to edit both sets of configurations at the same time and only send them to the DAS once.

Figure 2 - 32 Send Serial PPP parameters

If using AT/Modem - Line Mode:

1. Select the **Modem** button to adjust the modem settings.

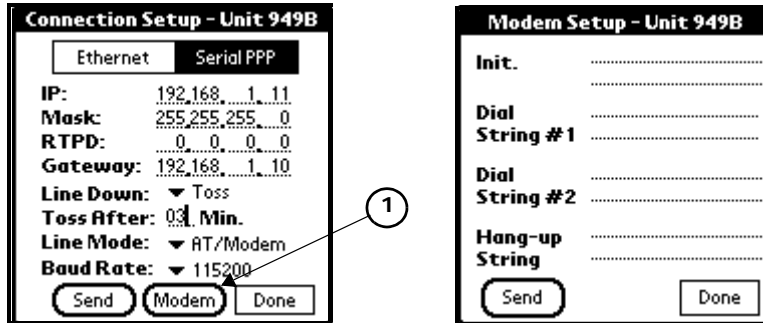

Figure 2 - 33 Modem setup screen

2. Tap after the **Init.** field and provide the modem initialization parameters as shown below (**ATEOSO=1**).

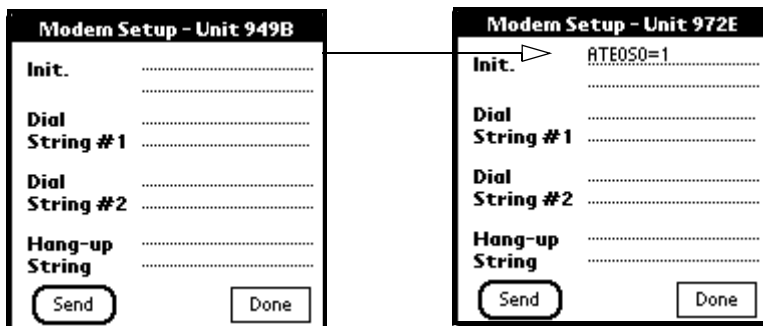

Figure 2 - 34 Modem Init string



Note: Type the init string exactly as shown above.

3. Tap the **Send** button to send the modem parameters to the DAS.
4. Tap the **Done** button to return to the Connection setup menu.

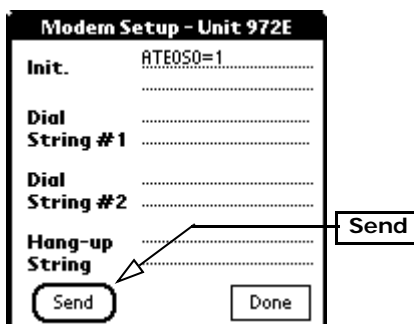

Figure 2 - 35 Send the modem parameters

2.5 Using the RAM button

To Clear, Dump or Update the DAS RAM:

1. Click the **RAM** sub-menu as shown below.

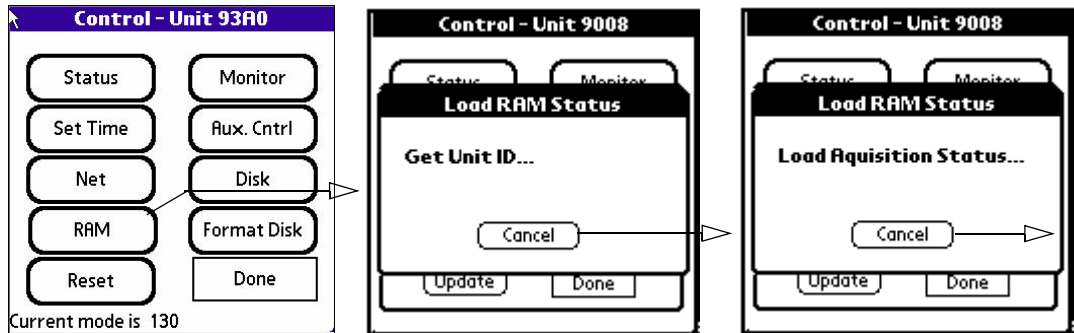

Figure 2 - 36 RAM commands

2. A sub-menu opens to prompt for a **RAM** command to **Clear, Update** or **Dump** RAM.

To clear the RAM:

1. Click the **Clear** option on the display.
2. Click the **OK** button to clear the RAM.

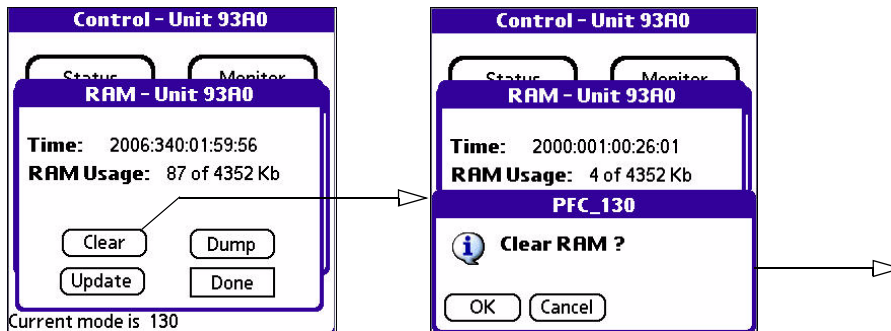
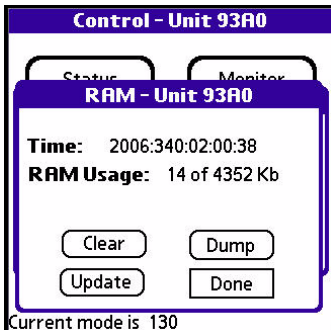

Figure 2 - 37 Clear RAM display



To update the RAM display:

1. Click the **Update** option and the usage will be updated on the display.

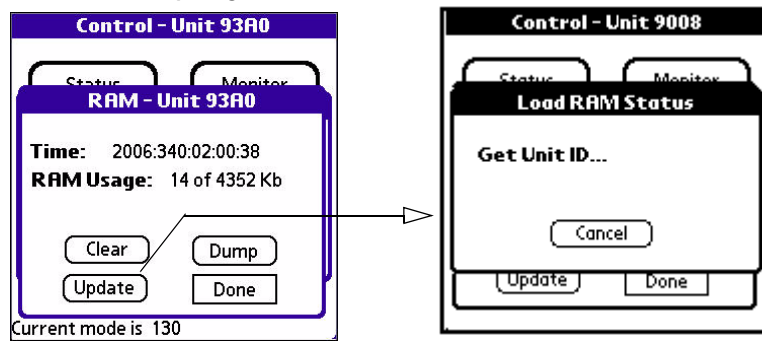
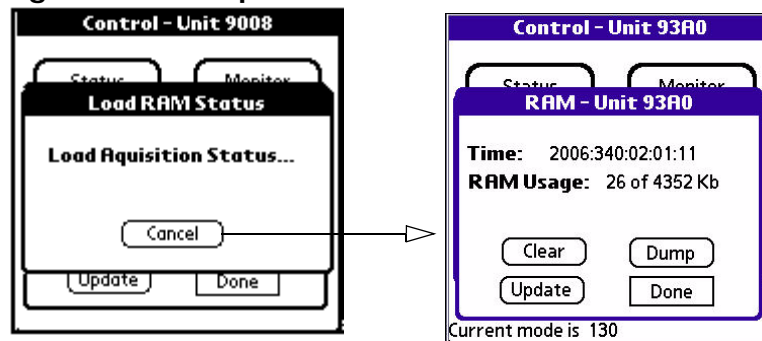

Figure 2 - 38 Update RAM status



To dump the RAM to disk:

1. Click the **Dump** option.



Note: This will cause the DAS to start the disk and write all data destined for the disk to the disk. It will NOT write data destined for the Ethernet or Serial PPP ports to the disk

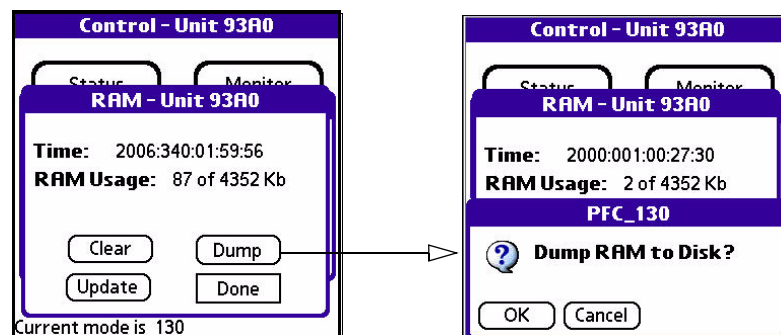

Figure 2 - 39 Dump option

2.6 Using the Reset button

To reset the DAS:

1. Click the **Reset** button as shown.
2. Click the **OK** button to reset the DAS.

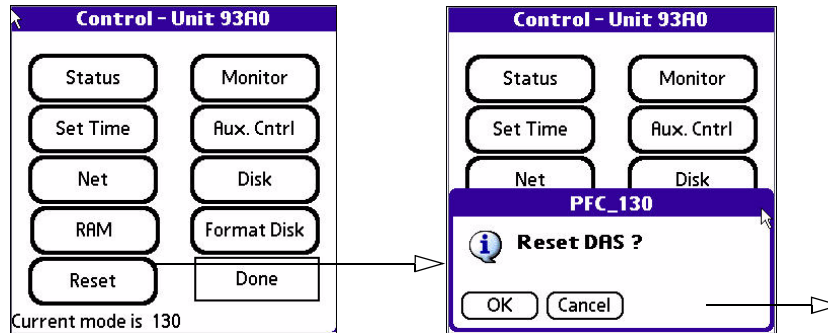
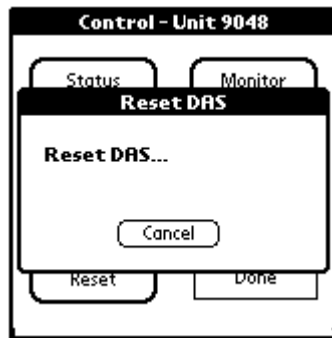

Figure 2 - 40 Reset the DAS

3. A submenu will open asking to confirm the reset of the DAS.



2.7 Using the Monitor function

The monitor function is used to check data acquisition with the PDA device. For example: The DAS records 8 seconds of data, filters and decimates to 20 sps. This resulting data is returned to the PDA device and displayed.

1. Click the **Monitor** button to check a particular stream and channel.
2. Click an active stream.
3. Click an active channel.
4. Click the **View** button.

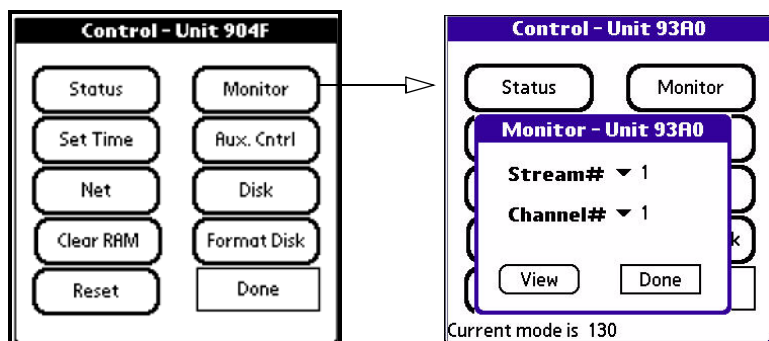

Figure 2 - 41 Monitor function display

5. Wait for the data image to display.
6. To select a different channel or stream click the **Ch Sel** button and set the desired channel.
7. Click the **Update** button to re-generate the same channel's waveform.

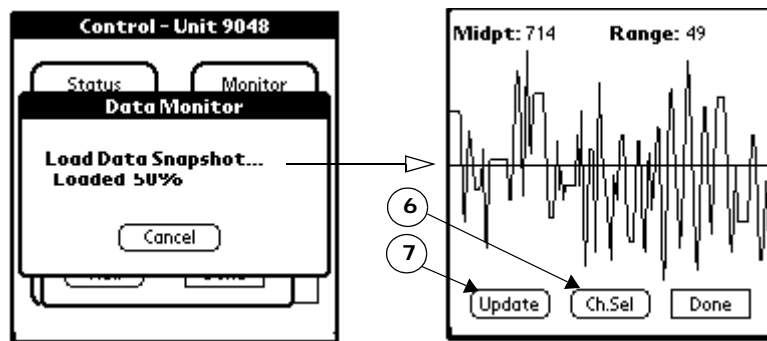

Figure 2 - 42 Display monitor command results



Note: The display shows the Midpoint of the data and the peak-to-peak Range of the data.

8. The **Update** button will re-display the same channel's waveform.

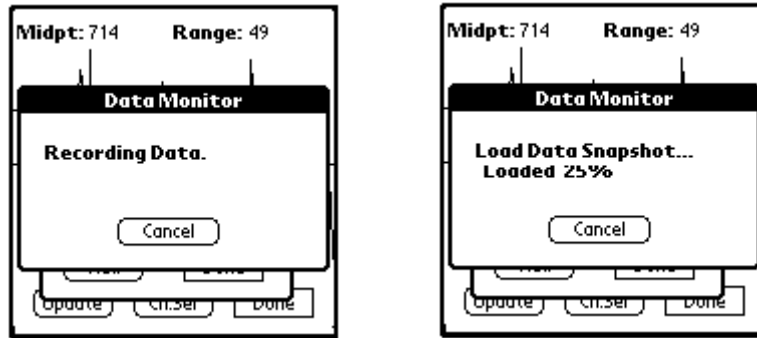
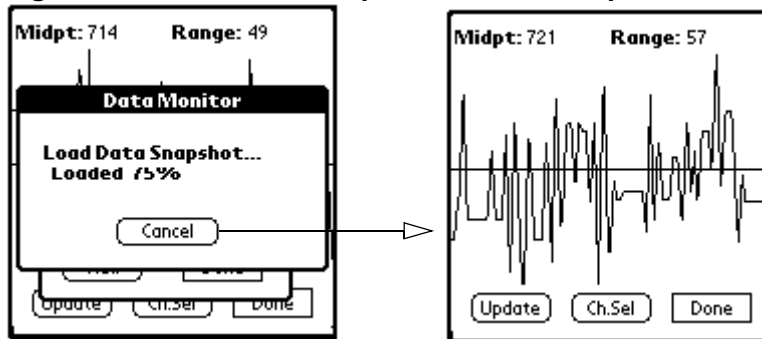

Figure 2 - 43 Monitor update button sequence



2.8 Using the *Auxiliary Control* button

Use the **Aux. Cntrl** to check offset, test the internal (ANSS) accelerometer, run on-demand mass re-centering, measure mass position of the connected sensor, test the DAS memory, or generate the test signal out to the sensor.



Note: The Test 1-3, Test 4-6, and Aux Ch. buttons all require the 130 DAS to have a Sensor Control board (RT527) to be installed.

1. Click the **Aux. Cntrl** button as shown.

A submenu will open to click:

Menu button	Description
Offset	Record each channels offset and store an offset correction.
ANSS Sensor Test	Send a test pulse to the internal accelerometer.
Test 1-3	Generate, the previously defined test signal, output on the channel 1-3 connector.
Test 4-6	Generate, the previously defined test signal, output on the channel 4-6 connector.
Aux Ch	Used to measure mass position or other auxiliary input data. Also provides the option for on-demand mass re-centering.
RAM Test	Used to cause the DAS to perform a check on the memory.

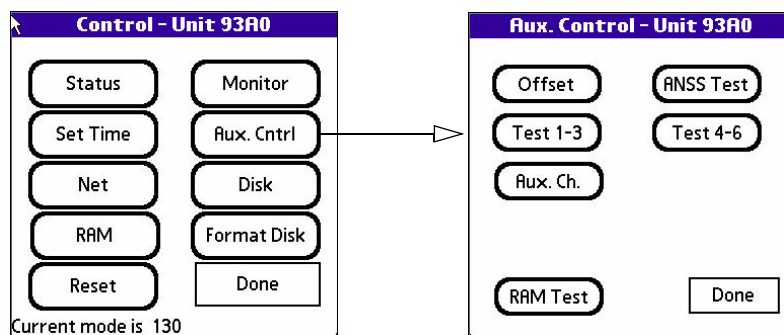

Figure 2 - 44 Test options - Aux. Cntrl



Note: The test 1-3 and test 4-6 buttons cause the activation of the sensor test signal as defined in the sensor test parameters. See the section "Sensor Test" on page 3-74 to define the parameters.

2.8.1 Using the Offset Option

Use the **Offset** option to record each channels offset and to also store an offset correction value. This stored value is removed from each data sample as it is recorded to the datastream.



Note: The offset is an average taken over the specified length of time. Precaution should be taken so as to not disturb the sensor while the offset calculation is occurring.

1. Click the **Offset** option.

On the Offset Stream display:

2. Choose an active stream.
3. Set an offset length (time in sec).
4. Click the **Calculate** button.

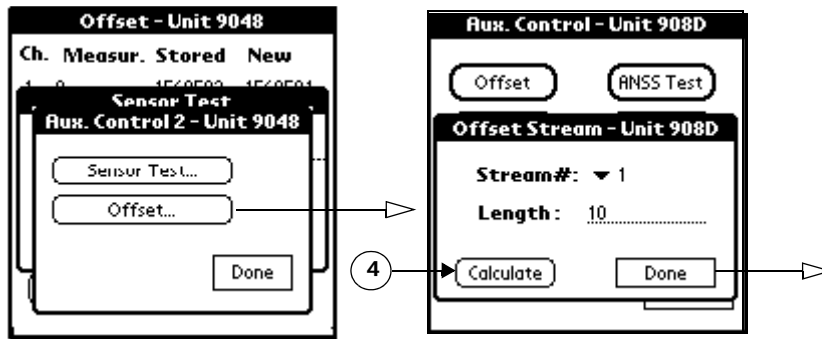

Figure 2 - 45 Offset settings screen

5. Screens open and update as an offset is calculated.



Figure 2 - 46 Calculating Offset

6. Click the **Store** button to store the new offset.

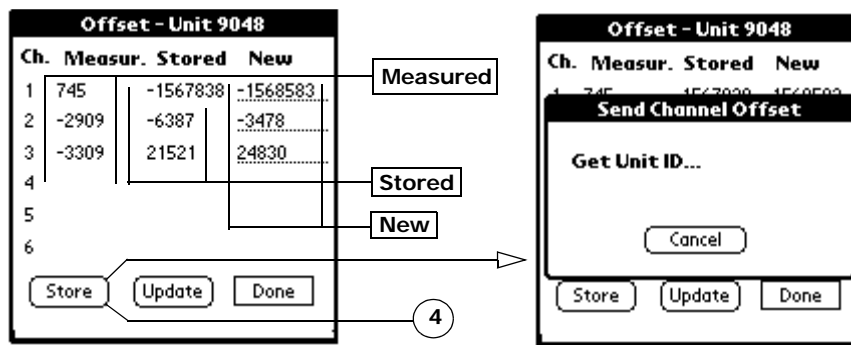

Figure 2 - 47 Store the offset and display the results

7. After results are displayed, click the **Update** to re-calculate and re-display.

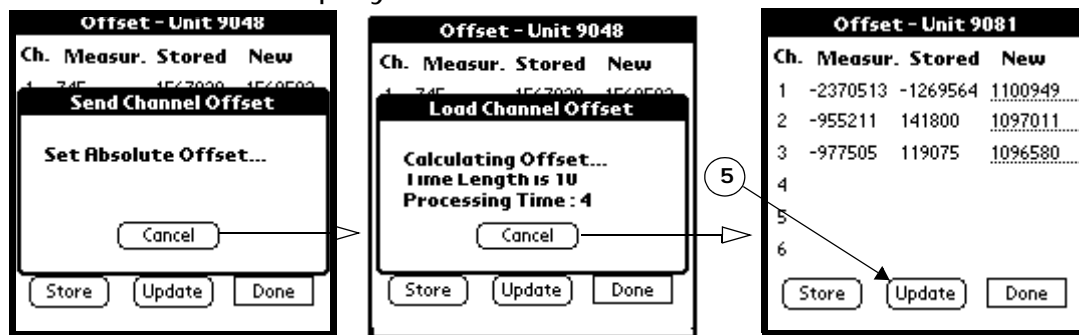

Figure 2 - 48 Store the offset value

The **Measured** offset is the average value for each channel over the specified length of time. The **Measured** offset includes the subtraction of the **Stored** offset value. This calculation is done within the DAS on every data sample.

The stored value is the currently stored value in the DAS. The DAS is currently subtracting this stored value from every data sample.

The **New** offset value is the negated difference value (**Measured - Stored**). The **new** value replaces the **Stored** offset value in the DAS when the **Store** button is selected.

The **Update** button may be selected to calculate the offset again and re-display the results.

2.8.2 Using the ANSS Test

To test the internal ANSS sensor:

1. Click the **ANSS Test** option to test the internal accelerometer.



Figure 2 - 49 Send the internal accelerometer a test signal



Note: The test result will be a one second pulse of approximately 0.5 g magnitude that is recorded in the data for all channels of the sensor when the following is true:

- [1] Acquisition is on
- AND-
- [2] If a level trigger is set up (trigger level of less than 0.5 g)
- OR-
- [3] If a continuous trigger is set up

2.8.3 Generating a sensor test signal

1. To test the sensor, attached to channels 1-3, click the **Test 1-3** button.

The Sensor Calibration screen will display showing a forced activation of the specified sensor for 1-2 seconds. This outputs the test signal on the Channel 1-3 connector.

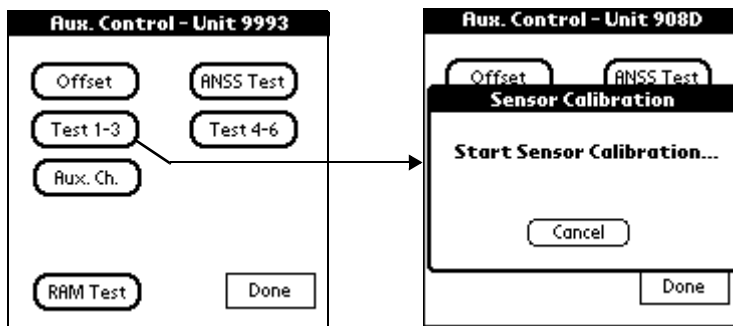

Figure 2 - 50 On-demand test sensor (ch 1-3)

- To test the sensor, attached to channels 4-6, click the **Test 4-6** button.

The Sensor Calibration screen will display showing a forced activation of the specified sensor for 1-2 seconds. This outputs the test signal on the Channel 4-6 connector.

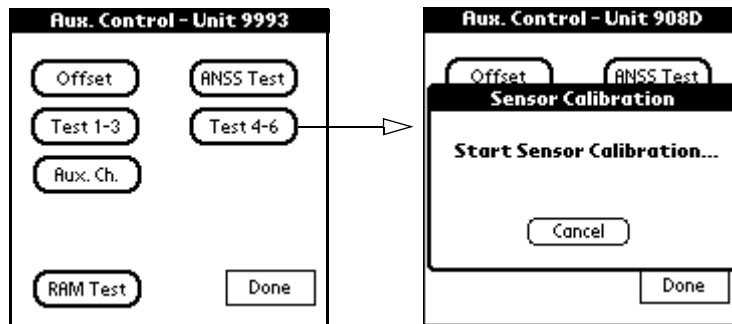

Figure 2 - 51 On-demand test sensor (ch 4-6)

2.8.4 Aux Channels

The Auxiliary channels can be used to measure mass position or other auxiliary input data such as temperature and wind speed. Three auxiliary channels are provided on each sensor connector. These channels are read once per second and stored.

The channels data can also be recorded (when used with auxiliary input data) by selecting the options in the Aux Data sub-menu screen (Figure 3 - 63 on page 3-69) on the Edit Configuration menu. The auxiliary data is recorded as datastream 9 in 16-bit format.

The Aux. Channels display in Figure 2 - 52 is an instantaneous display of the present state of each channel.

- Click the Update button to update the display values.
- Click **Center 1-3** to manually start sensor re-centering for the sensor attached to channels 1-3.
- Click **Center 4-6** to manually start sensor re-centering for the sensor attached to channels 4-6.

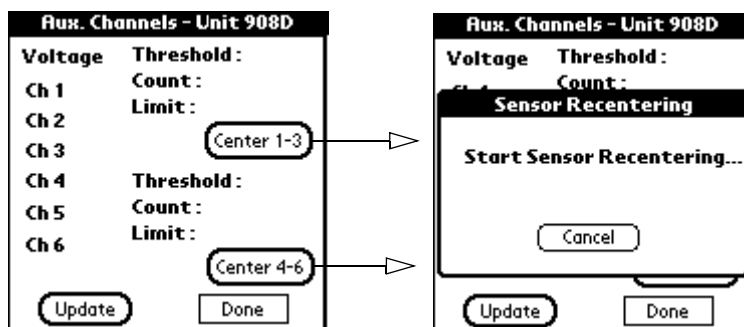

Figure 2 - 52 Aux Channels

2.8.5 RAM Test

This command is used to cause the DAS to perform a check on the memory. Acquisition will be stopped prior to starting the test and the DAS will attempt to flush any remaining data. A Pass or Fail (including 1st failing address) response will be sent. Upon completion of the test the DAS will be reset.

1. To test the DAS memory select the **RAM Test** button.
2. A warning screen will open to approve the test
3. Select the **OK** button to start the test

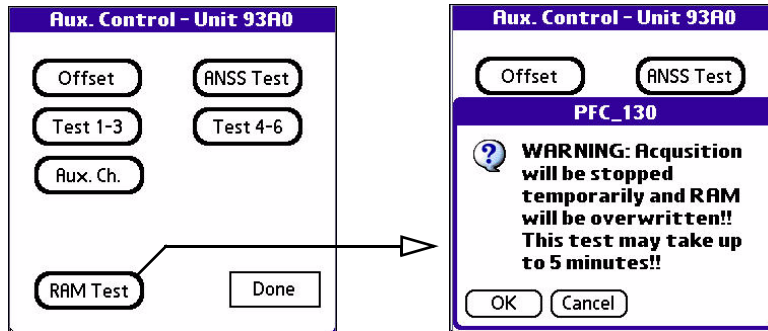
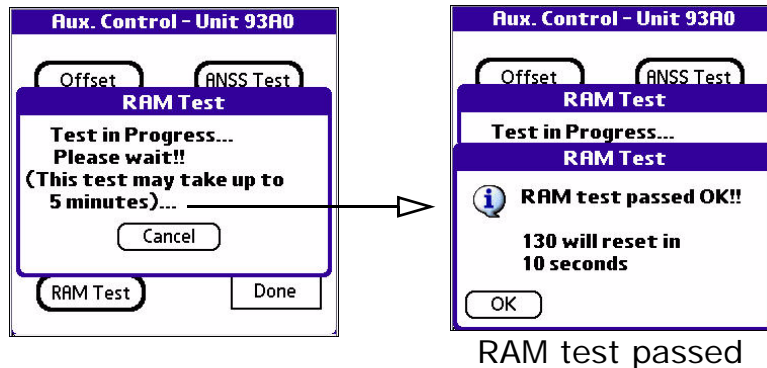

Figure 2 - 53 Aux Control - RAM Test

4. A screen opens to notify the test has completed and passed.
If the test fails a different screen opens to display the 1st failing address.



2.9 Using the *Disk* parameter button

To dump the disk:

1. Click the **Disk** menu.
A disk configuration submenu will open to allow setting the dump threshold.

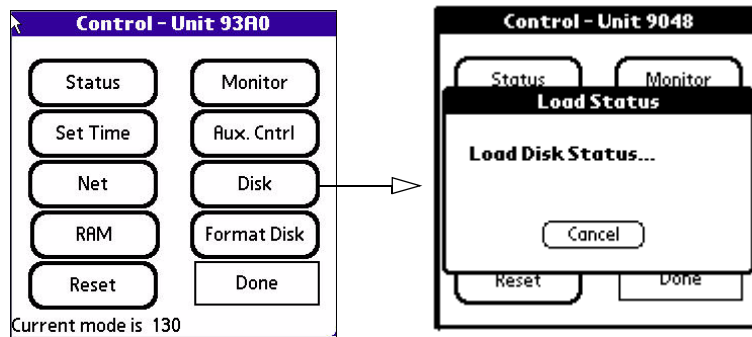

Figure 2 - 54 Set the Disk Dump Threshold and Dump the Disk

2. Click after the **Dump Threshold** line (percentage of RAM set to when data is dumped to the disk from RAM) and enter a new threshold percentage.
3. Use the **Auto-wrap** drop-down to enable or disable over-writing of the oldest data recorded to disk.

Auto-wrap option	Action
Yes	When a disk fills the other disk is automatically reformatted and recording continues on the newly formatted disk. i.e. circular buffer containing most current data.
No	Recording begins with Disk 1 and stops when all available disks are full.

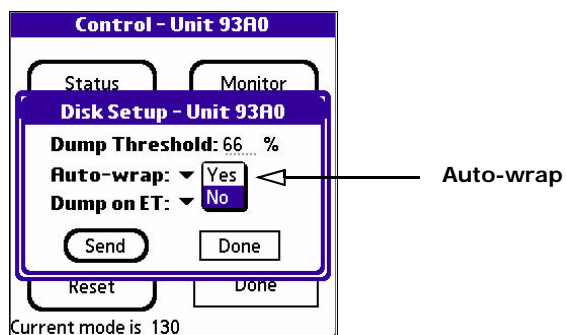

Figure 2 - 55 Auto wrap option

- Use the **Dump on ET** option to control when event data is written to disk.

Dump on ET	Action
Before CPU firmware version 2.7.3	Hard coded as disabled
After 2.7.3	
Yes	The DAS will write all remaining event data to the disk when the end of the event is detected and the ET packet is created.
No	The data will be dumped to the disk based on the setting of the Dump Threshold.

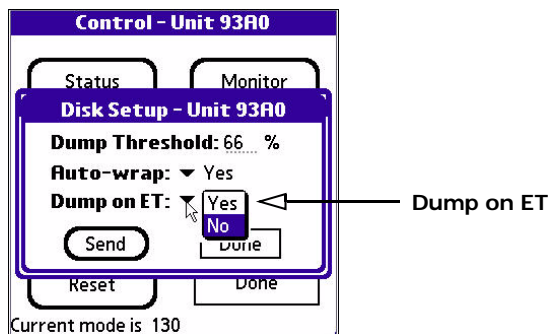

Figure 2 - 56 Dump on ET Option

- Click the **Send** button the new dump threshold to the DAS.

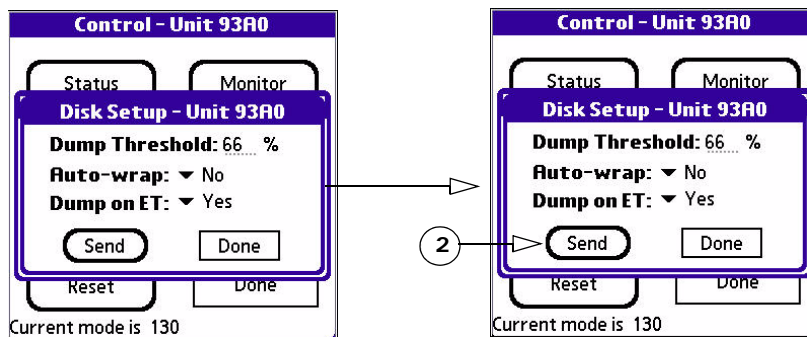

Figure 2 - 57 Send the dump threshold



Note: The dump threshold is expressed as a percentage of RAM. In the above display example, when the dump threshold is set to 66%, the DAS will power on it's disk and dump the data to the disk when the RAM reaches 66% full (66% is the default and recommended value).

Note: Two disks must be installed in the 130 to enable auto-wrap.

2.10 Using the Format Disk button

To format the disk:

1. Click the **Format Disk** menu on the **Control** menu.
2. Select the disk number to be formatted from the drop-down menu.
3. Click the **Start** button to start the format or **Cancel** button to cancel the format.

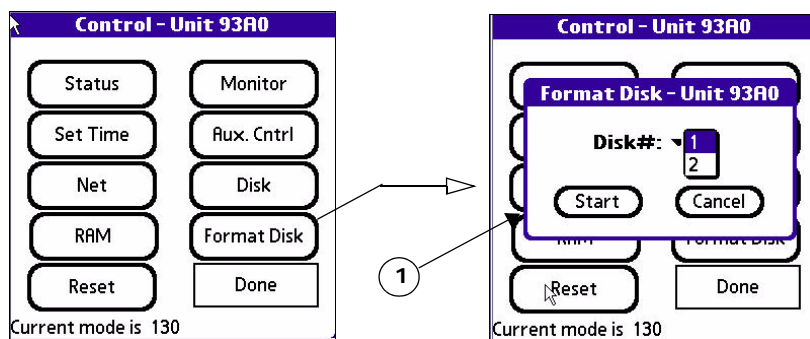
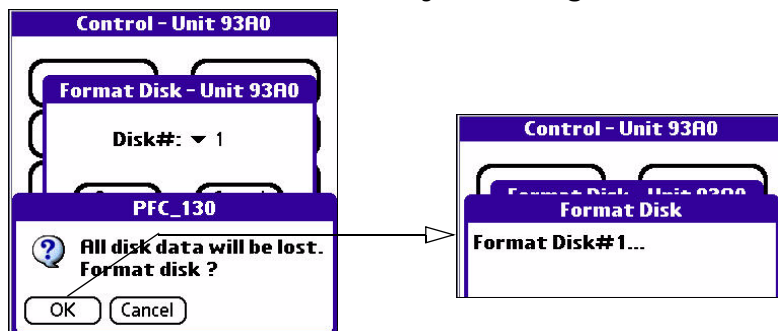

Figure 2 - 58 Format drop-down menu

4. Confirm the format by clicking the **OK** button.



Note: Once the format command has been issued to the DAS, there is no option to cancel the format.

5. When the format is complete the submenu displays "**Completed**" or "**Error**" with a **Done** button to return to the **Status** menu.

2.11 When the Control Menu does not display

1. When the PDA cannot connect to the DAS the response *Get Unit ID* display (Figure 2 - 59) will remain until the **Cancel** button is touched
2. Click the **Cancel** button to cancel the operation.

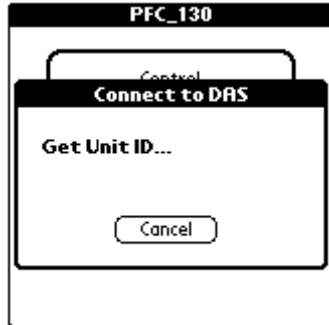

Figure 2 - 59 Get Unit ID display

3. The **Cancel Operation** button will display.
4. Click the **Yes** button to cancel the operation.



5. An error screen will open to confirm the operation has failed.
6. Click the **OK** screen to return to the main menu.



Figure 2 - 60 Error in connection display

Verify the following, if the PDA cannot communicate with the DAS:

1. Check the PDA to DAS cable connections and reconnect.
2. Verify the DAS settings are OK on the PDA and reconnect.
3. Click the **Control** button on the **PFC_130** main menu screen to communicate with the DAS.



Section 3 Configuration Screens

3.1 Using the *Configuration Manager* Menu

The Configuration Manager section is used to establish a particular parameter record. This section is written describing each screen and its features.

The program contains 3 parameter input screens (**New**, **From DAS**, and **Load** sub-menus) and a **Parm Status** command to check the current configuration. You can enter parameter settings in any order, however this section should be used in order of operation to enter your particular parameter settings.

3.1.1 Using the Configuration manager menu

1. From the **PFC_130** main menu select the mode of operation from the **Mode** pull-down menu.



Note: If the desired mode of operation is for use with the 130B use the *PFC_130B User Guide*. This manual includes the 130, 130G, and 130Q versions of PFC_130.

2. Launch the Configuration Manager program by selecting the **Work with Configuration** menu.

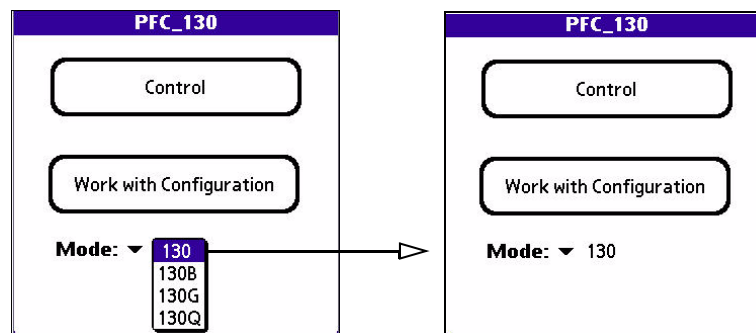

Figure 3 - 1 PFC_130 Main menu

3. The *Configuration Manager* menu (Figure 3 - 2) is displayed.

The Configuration Manager sub-menus are as follows:

- Enter new parameters for the DAS - **New**
 - Get parameters already in the DAS - **From DAS**
 - Load parameters already setup in the PDA - **Load**
 - Check parameters status - *Parm Status*
4. Click any of the sub-menus to activate that parameter screen:
- For **New** configurations see “Configure the DAS for new parameters” on page 3-41.
 - To **Load** saved configurations see “Load a saved configuration” on page 3-94.
 - To check the status of active parameters see “Check parameter status” on page 3-95.
 - To check a configuration **From** the **DAS** see “From DAS” on page 3-97.

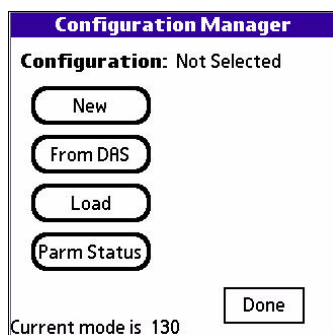

Figure 3 - 2 Configuration Manager menu

3.2 Configure the DAS for new parameters

Use standard PDA features and enter the new required parameter information for your particular experiment. These forms are designed to configure parameters which are station specific.



Note: When entering new parameters you must name the configuration first before entering information for the other parameters.

1. To create new DAS parameters click the **New** button as shown in Figure 3 - 3.
2. When the **New Configuration** submenu opens, enter a new parameter name, by clicking the line next to the configuration **Name** and the cursor will appear.
3. Click the **OK** button (in order to save and use the parameter file for reference later).

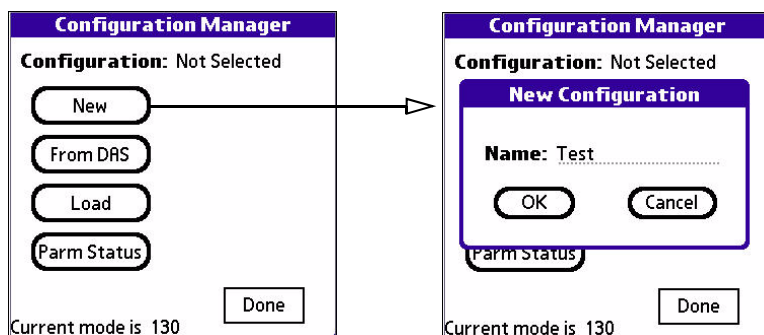

Figure 3 - 3 Configuration menu without configuration

4. The PFC_130 software then creates a new configuration with the new name and returns to the **Configuration Manager** menu.
5. The **Configuration** menu now shows the newly created configuration at the top of the menu (See Figure 3 - 4).

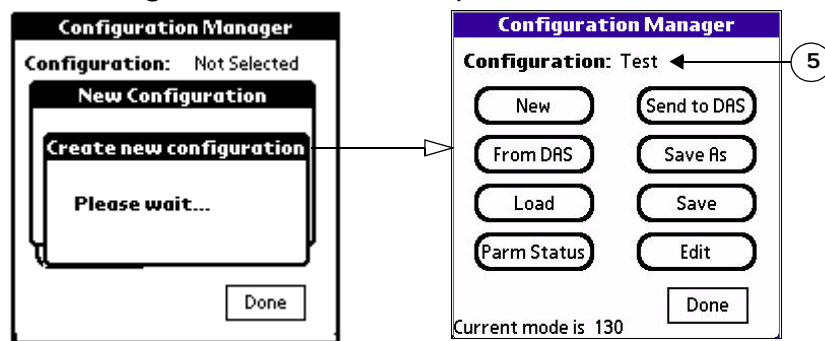

Figure 3 - 4 Adding a new parameter (configuration) name

3.3 Edit configurations

1. Click the **Edit** button to add configuration information for the station, experiment, channels, and streams parameters with the **Edit Configuration** sub menu.

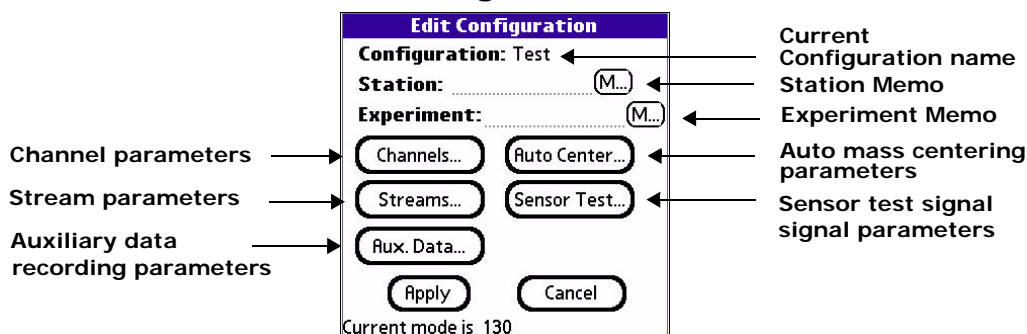

Figure 3 - 5 Edit or add parameters sub menu

2. Enter the Station name by selecting the blank area after the **Station** menu label.
3. After the cursor appears enter a station name with the PDA (See Figure 3 - 6).
4. Add station comment information by clicking the **M** button
5. Approve the comments by clicking the **OK** button.

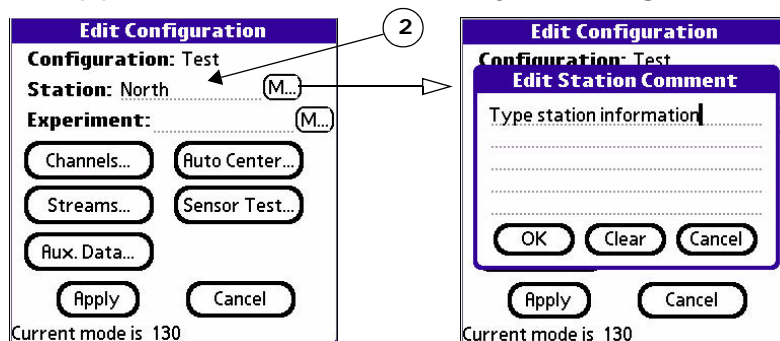

Figure 3 - 6 Edit Configuration menu

6. Enter the experiment name after the **Experiment:**.
7. Add the experiment comment information by the clicking the **M** button and adding comments in the field provided by taping in the field after the cursor.

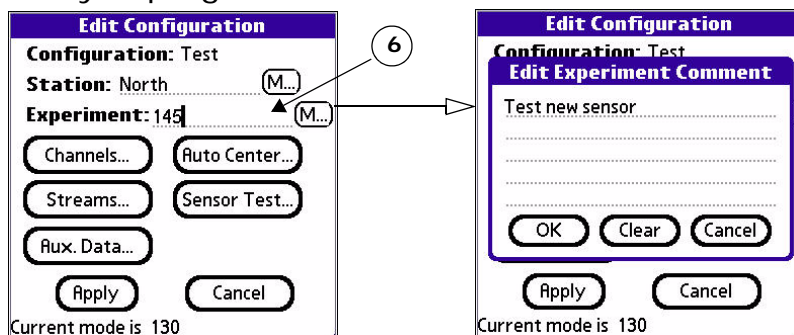

Figure 3 - 7 Experiment

3.4 Activate a channel

The display in Figure 3 - 8 shows all the channels available physically to the DAS and whether they are active.

To activate a channel and change its information:

1. Enter the Channel information by selecting the **Channels** submenu as shown in Figure 3 - 8.
The **Channels** submenu opens that displays channels information associated with the DAS.

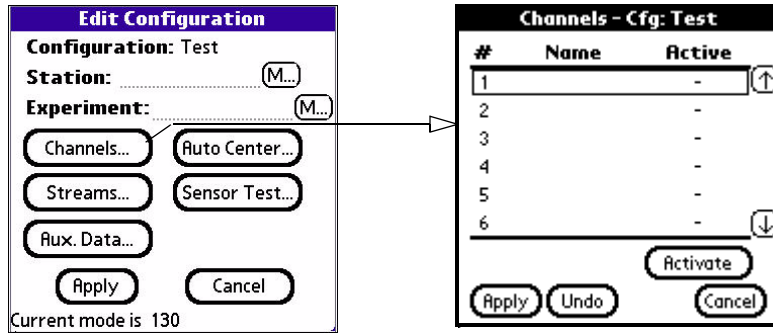

Figure 3 - 8 Channel submenu

2. Select the channel to be activated using the up-and-down arrows on the right side of the menu
3. Click the **Activate** button (as shown in Figure 3 - 9), to activate a channel that shows a (-) in the Active column.

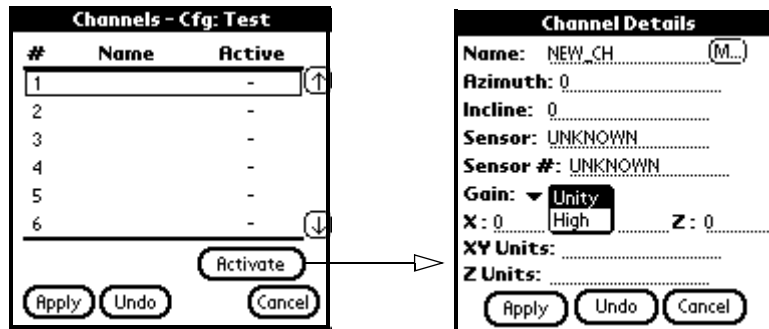

Figure 3 - 9 Activate channel submenu

4. Proceed to "Add channel details" on page 3-44.

3.4.1 Add channel details

1. The the Channel Detail display opens for the selected activated channel:

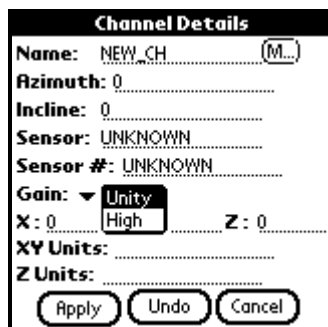

Figure 3 - 10 Channel details - Parameter entry

2. Click the **Name** field and enter a new name for the channel after the cursor.



Figure 3 - 11 Channel name

3. Add channel comments, if applicable, by selecting the **M** window as shown in Figure 3 - 12
4. Approve the channel comment by clicking the **OK** button.

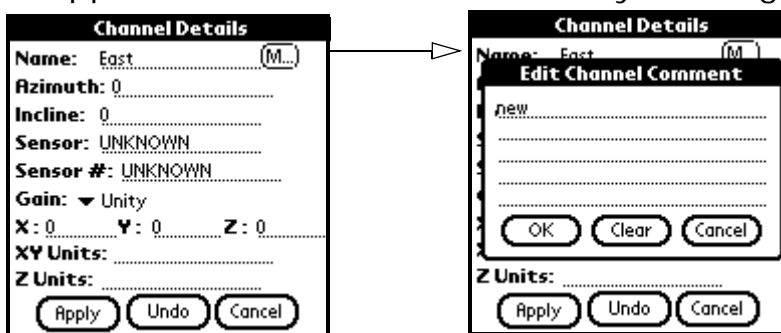
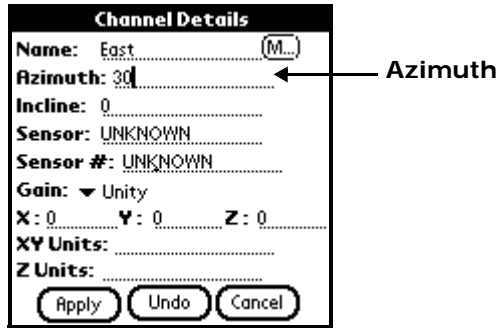

Figure 3 - 12 Adding Channel comments

5. Enter the Azimuth information by selecting the line after the **Azimuth** field on the display and entering the horizontal angle.



6. Enter the Incline by selecting the line after the **Incline** field on the display and entering the rate of slope.
7. Enter the Sensor model by taping the line after the **Sensor** field on the display and entering the sensor model name for the selected channel.
8. Enter the Sensor serial number by clicking the line after the **Sensor #** field on the display and entering the sensor serial number.

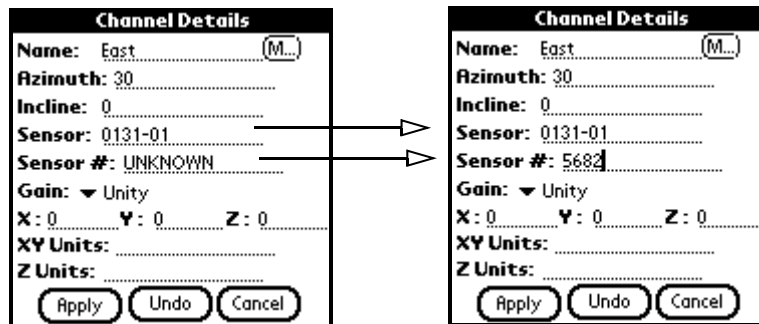
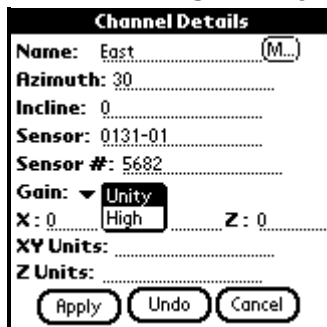

Figure 3 - 13 Enter the sensor model and serial number

9. Set the gain by selecting from the drop-down menu.



- The *Unity* gain setting selects the first gain stage of the 125A, which is typically a gain of 1.
 - The *High* gain setting selects the second gain stage of the 125A, which is typically a gain of 32.
10. Enter the X location by touching the line after **X** on the display and entering the X location of the unit.
 11. Enter the Y location by touching the line after **Y** on the display and entering the Y location of the unit.

12. Enter the Z location by touching the line after **Z** on the display and entering the Z location of the unit.
 13. Enter the XY Units by touching the line after **XY Units** on the display and entering the XY units of measure.
 14. Enter the Z Units by touching the line after **Z Units** on the display and entering the Z units of measure.
 15. Click the **Apply** button (Figure 9) to apply the updates and return to the **Channels** menu.
- OR-
16. **Undo** to erase all the updates that were done and start over entering information for the selected channel.



Figure 3 - 14 Channel Details

17. Select another channel with the up-and-down arrows to add settings or deactivate.

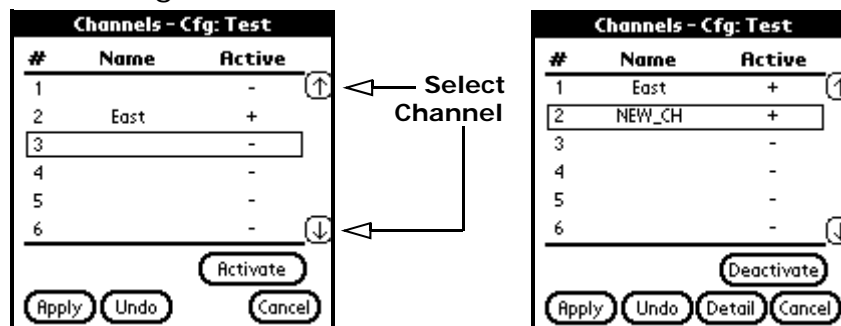

Note: After adding channel details, activate or deactivate other channels by repeating “Activate a channel” on page 3-43 and “Add channel details” on page 3-44 to activate a channel or refer to “Deactivate a channel” on page 3-47.

18. After all the channels are updated as needed select the **Apply** button to return to the **Edit Configuration** Menu.

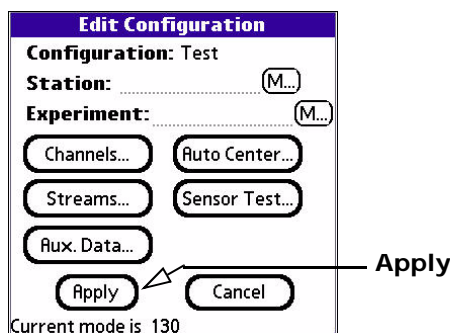

3.4.2 Deactivate a channel

If the channel selected is active, the channel shows a (+) in the active column (as shown on the left side of Figure 3 - 15), a **Deactivate** button and a **Detail** button to change the Channel details.

1. To deactivate a channel select the channel to be deactivated (see Figure 3 - 15) with the up-and-down arrows.
2. Click the **Deactivate** button for the channel that has been selected.

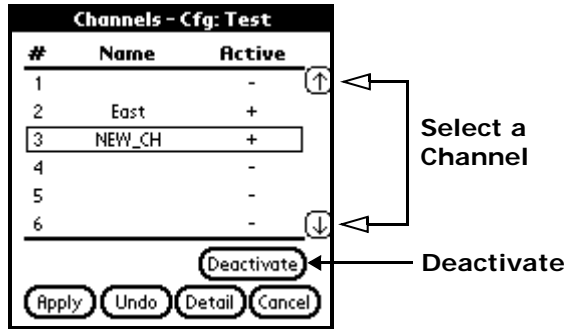

Figure 3 - 15 Deactivate a channel

3. The **Channels** display will re-open showing a (-) for the channel that was deactivated.
4. To return to the **Edit Configuration** menu click the **Apply** button on the **Channel** menu.

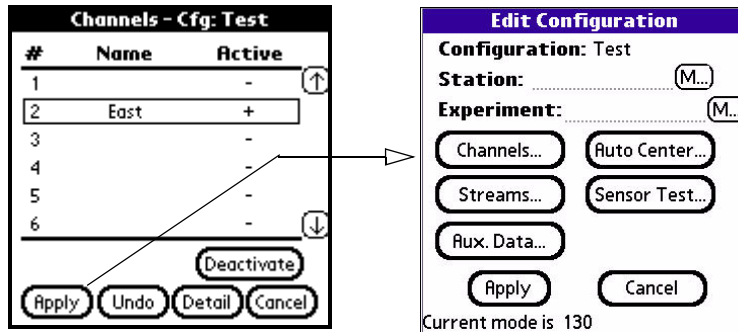

Figure 3 - 16 Return to the Edit Configuration from Channels

3.5 Define datastreams

On the Edit Configuration menu:

1. Click the **Streams** button to activate the **datastream** menu.
2. Select the datastream, using the up-down-arrows, to make or change parameter settings. These are located on the left side of the display screen and available streams are numbered 1 through 8.
3. Select specific '-' datastream recording destination(s) by selecting the **D** (*Disk*), **E** (*Ethernet*), and/or **S** (*Serial*) checkbox(s).

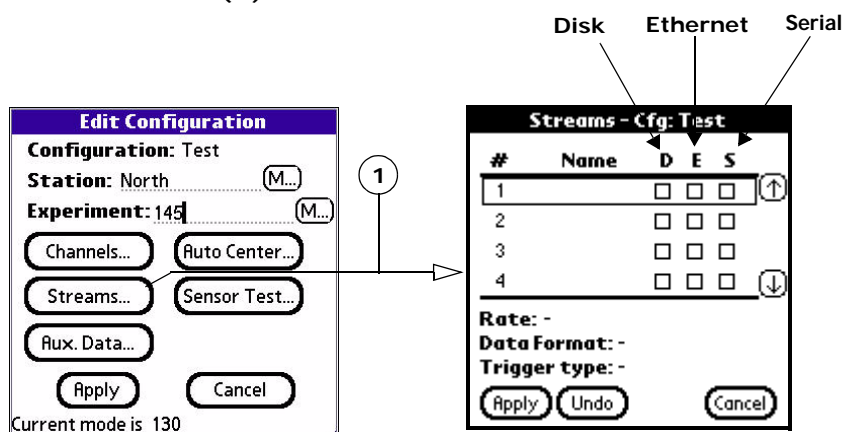

Figure 3 - 17 Configuration Menu (Edit Streams)



Note: More than one destination is acceptable. If using the NET port, see Figure 2 - 23 on page 2-16, verify the Ethernet Settings on the *Connection Setup* screen. Also verify the Host address is "zero-ed" out on the Serial PPP *Connection Setup* screen. If the Serial PPP RTPD address is set this will always be used as the RTPD host for Server Discovery.

4. Click the **Detail** button to open the **Stream Details** menu.

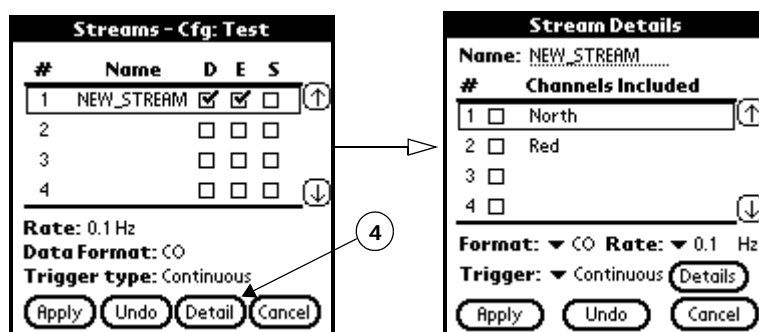

Figure 3 - 18 Activate Datastreams

5. Proceed to the "Add stream data details" on page 3-49.

3.5.1 Add stream data details

1. Change the default NEW_STREAM by touching the **Name** field on the **Stream Details** display and entering a name with the PDA (Figure 3 - 19)

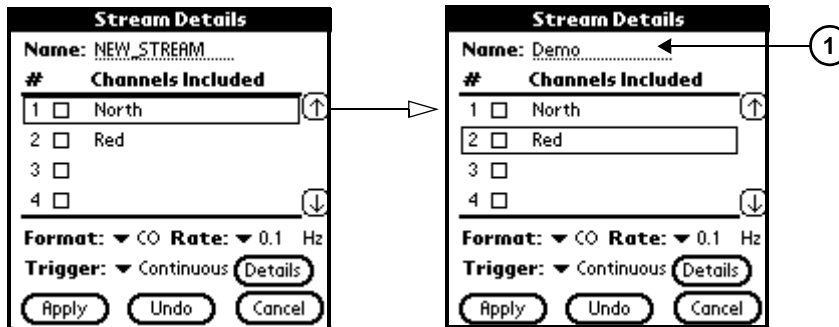

Figure 3 - 19 Stream Details- Parameter entry

2. Check off the channels to be included by selecting the square box after the channel number.

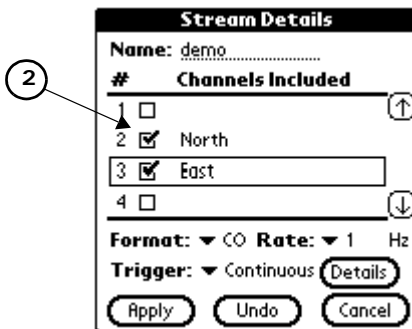

Figure 3 - 20 Stream Details - Channel check-off

3. Using the **Format** pull-down, choose the data format for the datastream (**CO** for compressed, **32** for 32-bit, or **C2** for highly compressed).

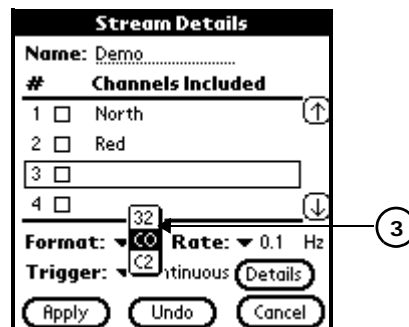

Figure 3 - 21 Set datastream format

- Select the sample rate (Hz') from the pull-down menu, using the following guidelines.

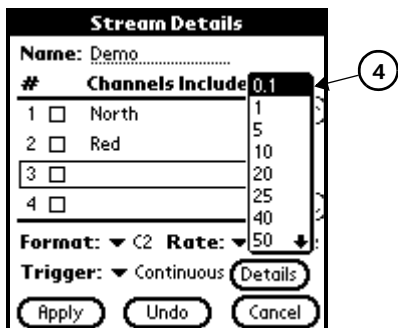

Figure 3 - 22 Set datastream sample rate

The sample rate list can be broken into two groups:

- Group One: The following rates are only available when recording a single sample rate for all streams: 1000, 500, 250, 125, 50 and 25.
- Group Two: The following rates may be recorded in any combination for multiple streams: 200, 100, 40, 20, 10, 5, 1 and 0.1.

Case	Description	Example of
Selection of a sample rate from Group One.	When the user activates any of the other datastreams, the sample rate chosen must be the SAME.	Selection of 125 SPS for datastream 1. This means that when datastream 2 is activated the sample rate is fixed at 125 SPS and there are no other sample rate choices available.
Selection of a sample rate from Group Two.	When the user activates any of the other datastreams, ANY of the group two sample rates can be chosen.	Selection of 40 SPS for datastream 1. This means that when datastream 2 is activated the choice is selection of any of Group two sample rates (200, 100, 40, 20, 10, 5, 1, or 0.1).

All six channels run at the same base sample rate at this time.

- Finally select the type of **Trigger** for this stream from the pull-down menu.

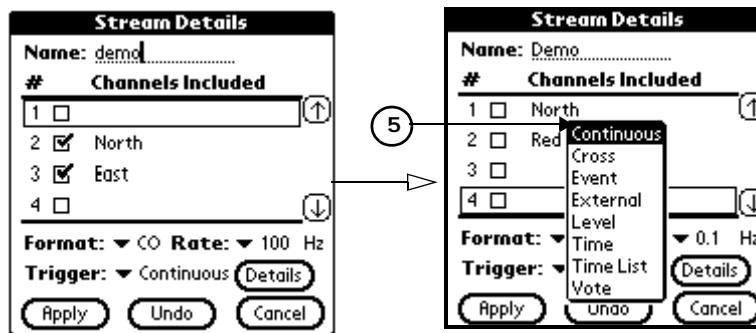

Figure 3 - 23 Trigger type selection



Note: Only one trigger may be set for a datastream. Each trigger selection will open a configuration submenu for the type of trigger selected.

- Go to the **Trigger** type submenu section required, as shown below, and enter the required information.

“Configure a Continuous Trigger (CON)” on page 3-52

“Configure a Level Trigger (LEV)” on page 3-54

“Configure a Cross Trigger (CRS)” on page 3-57

“Configure an Event Trigger (EVT)” on page 3-59

“Configure an External Trigger (EXT)” on page 3-62

“Configure a Time Interval Trigger (TIM)” on page 3-63

“Configure a Time List Trigger (TML)” on page 3-66

“Configure a Vote Trigger (VOT)” on page 3-68

3.5.2 Configure a Continuous Trigger (CON)

The **Continuous Trigger** event activates as soon as the DAS starts acquisition, provided the initial start time has already passed. The DAS terminates the event when the record length is reached, then automatically re-triggers recording data to the next event. See the *130 Theory of Operations* for more information.

Select **Continuous** as the trigger type from the pull-down menu:

1. Click **Continuous** on the trigger pull-down and the **Continuous Trigger** menu opens.
2. Click in the **Record Length** field and enter the amount of time (seconds) per event that the DAS will record data.
3. Click the **Time** window (initial start time) after the **Time** on the display to bring up the **SetDate & Time** submenu as shown below.

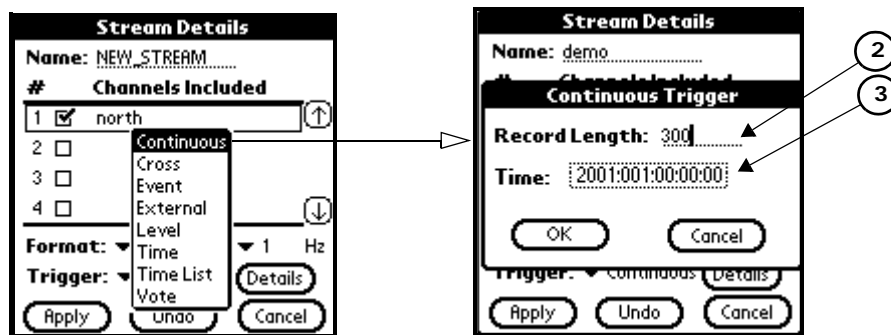

Figure 3 - 24 Continuous Trigger submenu

4. Tap the **Date** window on the **Set Date & Time** submenu.
5. The **Set Date** submenu opens to select the date.

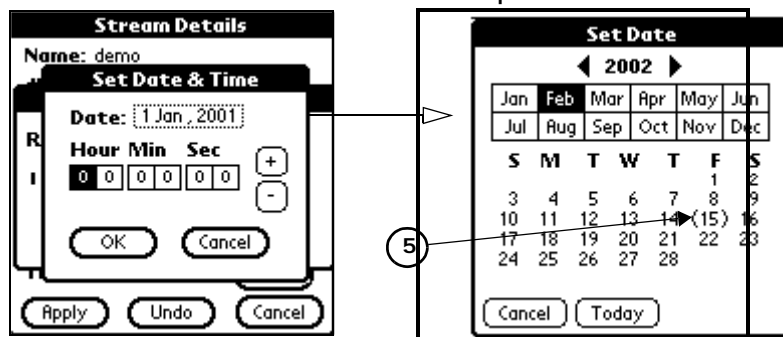

Figure 3 - 25 Set Date & Time submenu



Note: Set the date by selecting the date box after the *Date* field on the submenu display to open the *Set Date* submenu and selecting the correct month and day.

- Set the trigger time by selecting the **Hour**, **Min** and **Sec** windows and using the plus and minus buttons to increment the numbers as shown.



Note: This is a required field, otherwise an event of this datastream will not be recorded. To start recording data as soon as DAS acquisition is started, set a trigger time that is prior to the current time.

- Approve the settings by clicking **OK** or **Cancel** to redo the settings.
- Click **OK** from the **Continuous trigger** submenu display to accept the update.

-OR-

- Click **Cancel** to select another type of trigger.

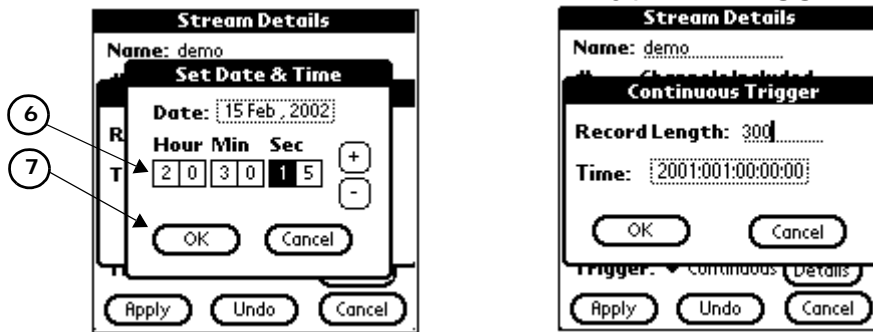

Figure 3 - 26 Set time

- After the **Stream Details** screen opens, click **Apply** to approve the stream settings and return to the **Streams** menu to select another datastream

-OR-

Click **Apply** from the Streams menu to return to the Edit **Configuration** menu.

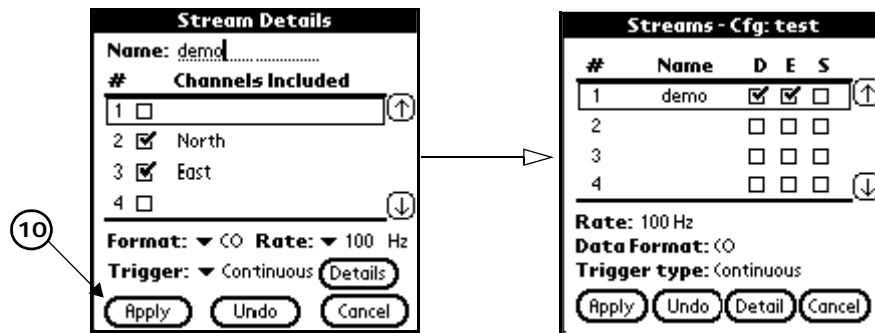

Figure 3 - 27 Continuous streams details

3.5.3 Configure a Level Trigger (LEV)

The **Level Trigger** specifies that data will be recorded when the amplitude of the data exceeds a specified threshold for any channel in the datastream. Level trigger recording stops when its record length is reached. Refer to the *Theory of Operation* (130_theory.pdf) for more explanation of this trigger.

Select **Level** as the trigger type from the pull-down menu:

1. Click **Level** on the trigger pull-down menu and the **Level Trigger** menu will open as in Figure 3 - 28.

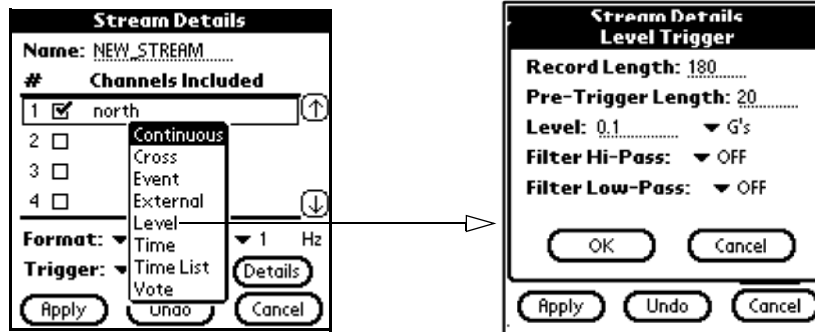

Figure 3 - 28 Level Trigger submenu

2. Click the **Record Length** field and enter the amount of time the DAS will record data including the pre-trigger length.
3. Click the **Pre-Trigger Length** field and enter the amount of data that the DAS will record with an event before recording the event itself.
4. Click the **Level** field and enter the absolute value range above which the input signal will cause a trigger.

5. Select the trigger **Level** value pull-down menu to change to G's (acceleration in G's), % F.S. (percent of full scale), or Counts (absolute digital counts).

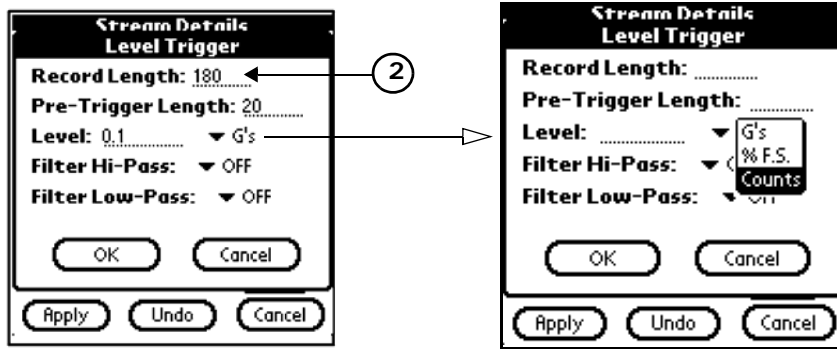

Figure 3 - 29 Level Trigger submenu

Trigger Level	Valid entry
G's	Allows up to 4 places of precision after the decimal point.
% Full Scale	Integer percent of full scale
Counts	Absolute digital counts

The Hi-Pass and Low-Pass filters are trigger filters only. They do not affect the data that is recorded.

6. Set the **Filter Hi-Pass** (high pass corner frequency in Hz) setting by selecting the drop down arrow beside the **Filter Hi-Pass** field.

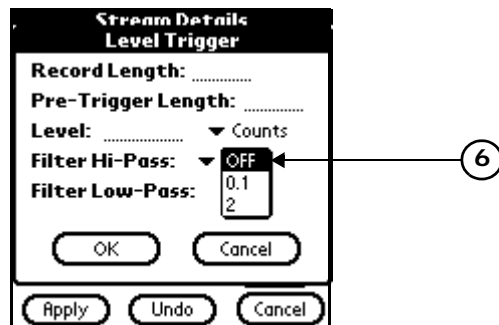

Figure 3 - 30 Level trigger Hi-Pass



Note: It is recommended to use at least the 0.1 Hz Hi-Pass filter for DC mean removal purposes.

7. Set the **Filter Low-Pass** (low pass corner frequency in Hz) setting by selecting the drop down arrow beside the **Filter Low-Pass** field.

8. Click **OK** from the display to accept the update

-OR-

Cancel to select another type of trigger or change settings.

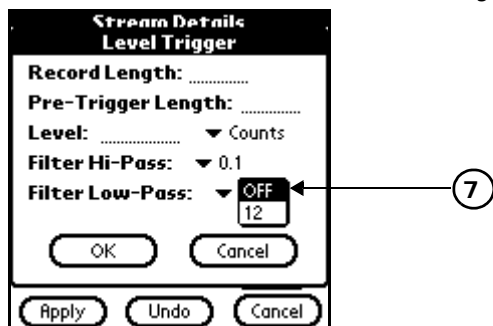
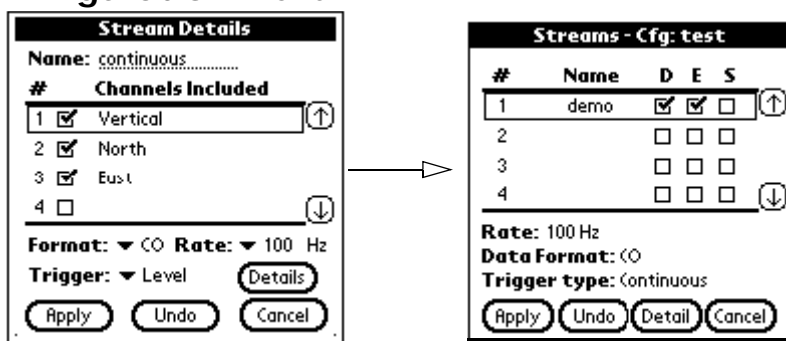

Figure 3 - 31 Level trigger Low-Pass

9. After the **Stream Details** screen opens, click **Apply** to approve the stream settings and return to the **Streams** menu to select another datastream.

-OR-

Click **Apply** from the **Streams** menu to return to the **Edit Configuration** menu.



3.5.4 Configure a Cross Trigger (CRS)

The **Cross Trigger** specifies that data will be collected on this datastream at the same time as another datastream. The event length is independent of the triggering datastream. With the cross trigger, you can trigger one datastream in conjunction with the triggering of another datastream. For more information see the *Theory of Operations* (130_theory.pdf).

Select **Cross** as the trigger type from the pull-down menu:

1. Click **Cross** on the trigger pull-down menu and the **Cross Trigger** menu will open.

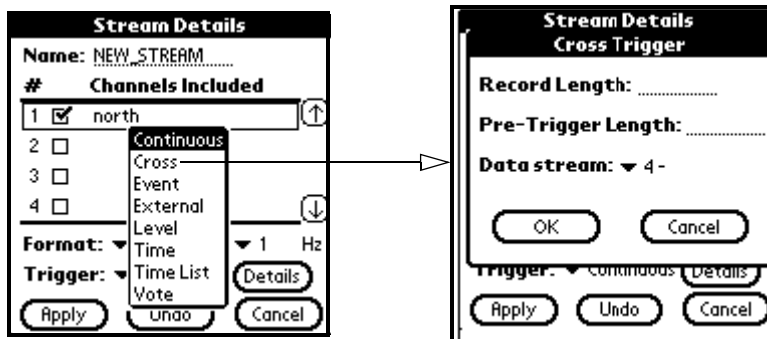

Figure 3 - 32 Opening Cross Trigger submenu

2. Click the **Record Length** field and enter the amount of time (seconds) the DAS will record data.
3. Click the **Pre-Trigger Length** field and enter the amount of data that the DAS will record with an event before recording the event itself.
4. Click the **Datastream** pull-down menu and select the number of the datastream that, when triggered, produces a trigger on this datastream.

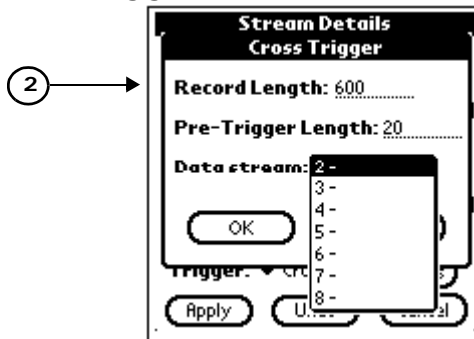

Figure 3 - 33 Cross trigger record length submenu

5. Click **OK** from the **Cross Trigger** display to accept the update.

-OR-

Click **Cancel** to select another type of trigger or change settings

- After the **Stream Details** screen opens, click **Apply** to approve the stream settings and return to the **Streams** menu to select another Datastream.
- OR-
- Click **Apply** from this menu to return to the **Edit Configuration** menu.

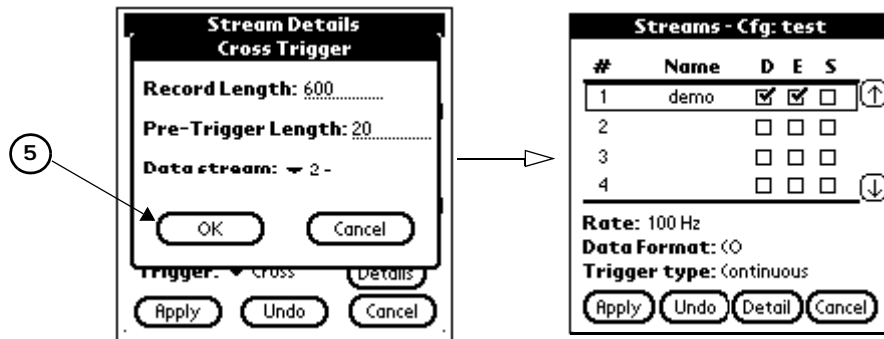

Figure 3 - 34 Closing Cross Trigger submenu

3.5.5 Configure an Event Trigger (EVT)

An **Event Trigger** specifies that data will be recorded when the ratio between the Short Term Average (**STA**) and the Long Term Average (**LTA**) exceeds a specified ratio for a minimum number of trigger channels. Only channels that are included in the Datastream may be used as trigger channels, but all included channels are recorded, even if they are not trigger channels. The length of the recording is always, at least, the length specified by the record length, but may be longer when a de-trigger ratio is specified. The post-trigger length is only used in conjunction with a de-trigger ratio. See the *130 Theory of Operations* manual for more information.

Select **Event** as the trigger type from the pull-down menu:

1. The **Event** on the trigger pull-down menu and the **Event Trigger** menu will open as shown in Figure 3 - 35.
2. Click the **Pre** trigger length field and enter the amount of time (seconds) that the DAS will record for each event before recording the event itself.
3. Click the recording **Length** field and enter a minimum recording length (seconds) for one event.
4. Click the **Post** trigger length field and enter the amount of time (seconds) that the DAS extends the recording after the de-trigger is declared. A value of zero indicates no post-trigger and is this fields default value.

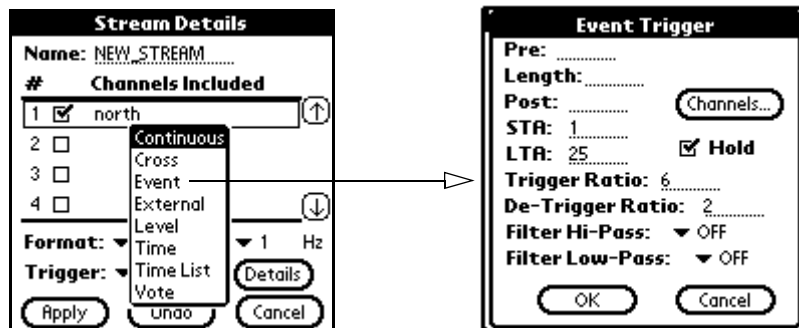

Figure 3 - 35 Event Trigger submenu

5. Click the **Channel** submenu.
6. Select the channels to be included in the event calculation by clicking the check boxes after each channel number.
7. Click after the **Min. Channels** field and enter the number of channels which must meet the trigger criteria before the DAS will activate an event trigger. Enter a value that does not exceed the number of channels included in calculations above.

8. Click after the **Window** field and enter a time interval during which the minimum number of channels, indicated above, must meet the trigger criteria for the DAS to activate an event.
9. Click **OK** to accept the update.

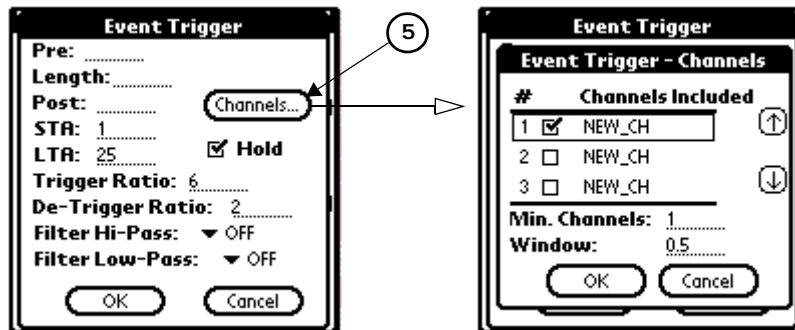

Figure 3 - 36 Event Trigger submenu and Channels



Note: Use Post trigger length only in conjunction with the de-trigger ratio.

10. Click after the **STA** (Short Term Average length) field and enter the number of seconds in which the DAS averages data using a running (exponential) average for STA.
11. Click after the **LTA** (Long Term Average length) field and enter the number of seconds in which the DAS averages data using a running (exponential) average for LTA.
12. Check the **Hold** check box to enable or disable LTA hold. This function causes the DAS to maintain a constant LTA when enabled.
13. Click after the **Trigger Ratio** field and enter a value that the STA/LTA ratio must exceed for the DAS to activate an event trigger.
14. Click after the **De-Trigger Ratio** field and enter the value that the STA/LTA must return to, after the DAS activates an event trigger, before the DAS will terminate the event.

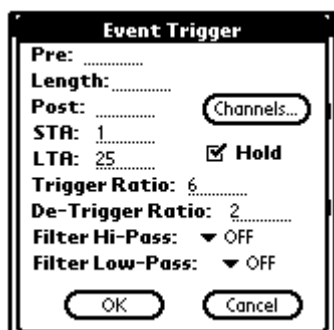

Figure 3 - 37 STA and LTA

- Click on the **Filter Hi-Pass** (high pass corner frequency in Hz) pull-down to turn on or off the Hi-Pass filter and select a value.

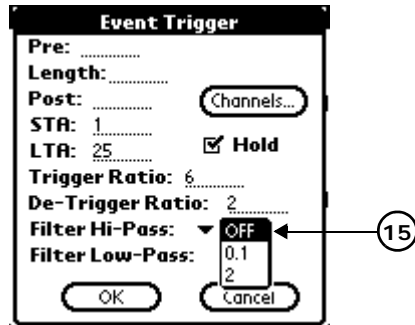

Figure 3 - 38 Event trigger Hi-Pass



Note: The Hi-Pass and Low-Pass filters are trigger filters only. They do not affect the data that is recorded. It is recommended to use at least the 0.1 Hz Hi-Pass filter for DC mean removal purposes.

- Click on the **Filter Low-Pass** (low pass corner frequency in Hz) pull-down to turn on or off the Low-Pass filter and select a value

Click **OK** from the display to accept the update or **Cancel** to select another type of trigger or change settings.

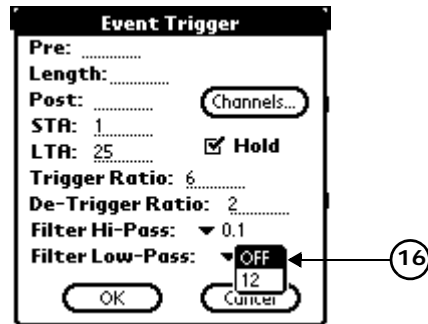
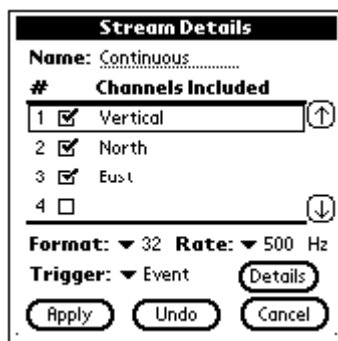

Figure 3 - 39 Event trigger Low-Pass

- After the **Stream Details** screen opens, click **Apply** to approve the stream settings, and return to the **Streams** menu to select another datastream,

-OR-

Click **Apply** from this menu to return to the **Edit Configuration** menu.



3.5.6 Configure an External Trigger (EXT)

The External trigger specifies that data will be recorded when an external pulse is detected by the DAS on the external trigger input line. The DAS terminates the event when the record length is reached. For more information see the *130 Theory of Operations* manual (130_theory.pdf).

Select **External** as the trigger type from the pull-down menu:

1. Click **External** on the trigger drop-down menu and the **External Trigger** menu will open.
2. Click after the **Record Length** field and enter the amount of time that the DAS will record data, including the pre-trigger length, to an event.
3. Click after the **Pre-Trigger Length** field and enter the amount of data that the DAS will record with an event before recording the event itself.

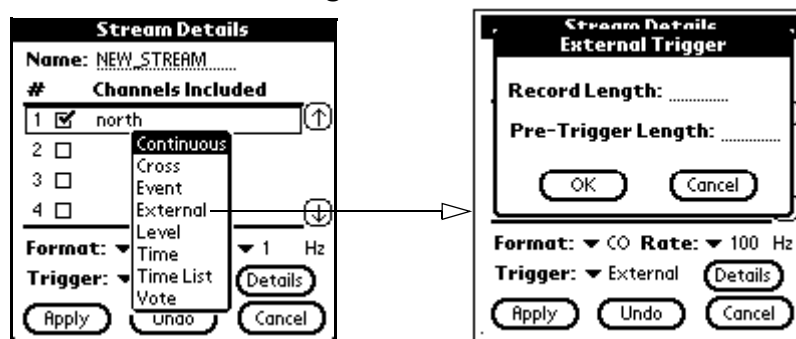

Figure 3 - 40 External Trigger submenu

4. Click **OK** from the display to accept the update
-OR-
Cancel to select another type of trigger or change settings.

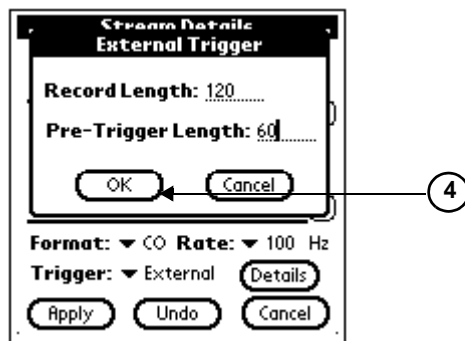

Figure 3 - 41 External trigger settings

5. At the **Stream Details** screen, click **Apply** to approve the stream settings and return to the **Streams** menu to select another datastream.
-OR-

Click **Apply** to return to the **Edit Configuration** menu.

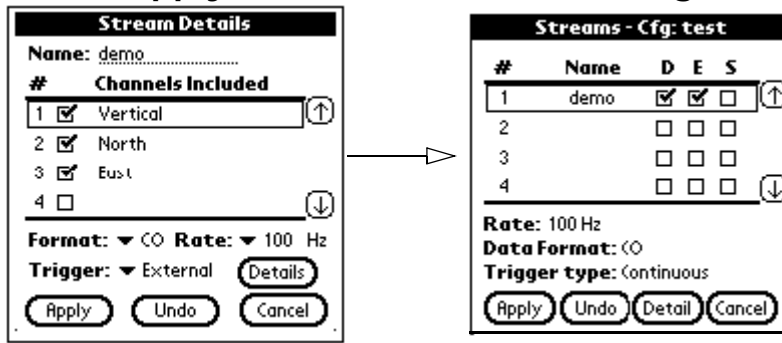

Figure 3 - 42 Stream Details to Datastreams

3.5.7 Configure a Time Interval Trigger (TIM)

The Time Interval trigger specifies that data will be recorded at specified intervals beginning when a specific time is reached. The Time Interval trigger event activates when the DAS unit’s internal time matches a specified time. The DAS terminates the event when the record length is reached. For more information see the *130 Theory of Operations* manual (130_theory.pdf).

Select **Time** as the trigger type from the pull-down menu:

1. Click **Time** on the trigger pull-down menu and the **Time Interval** trigger menu will open as in Figure 3 - 43
2. Tap the **Start Time** entry field and set the date and time.

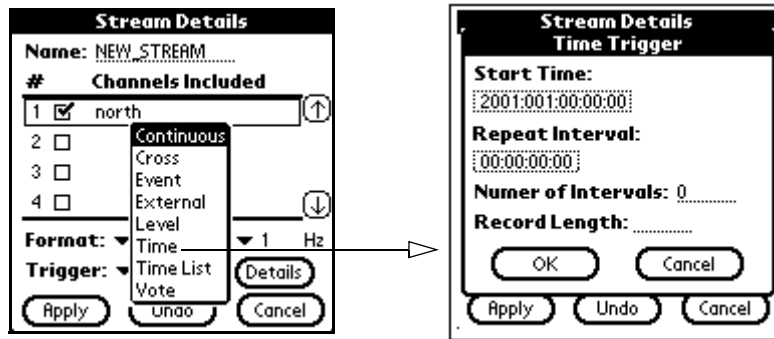

Figure 3 - 43 Time Trigger submenu



Note: This field has no default. If you do not set a start time the DAS will never record an event for this datastream.

3. Tap the **Date** field to set the date from the **Set Date** submenu. The DAS begins recording when its internal time matches the start time.
4. Set the time by selecting the **Hour**, **Min** and **Sec** windows. Use the plus and minus buttons to increment the numbers as shown

- Click the **OK** button to accept the **Start Time**.

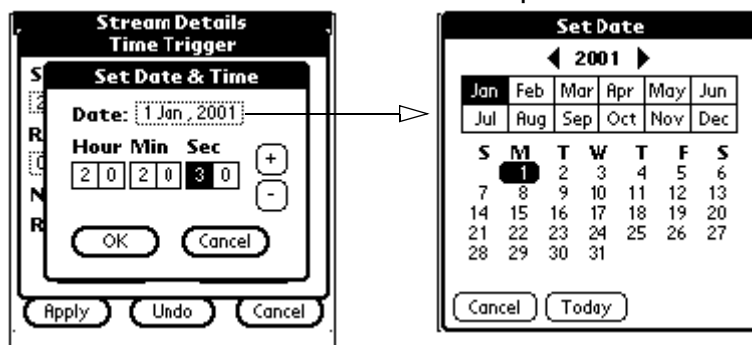
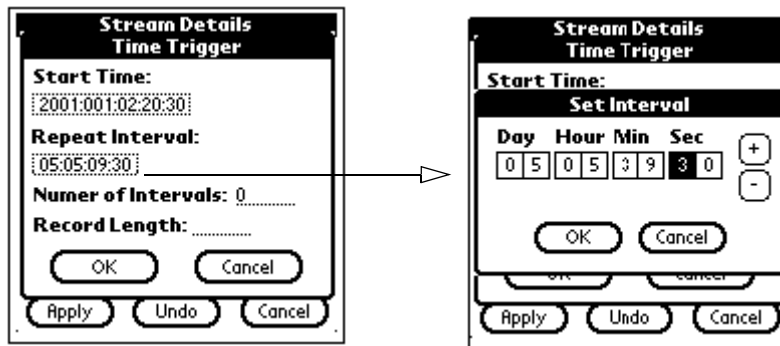

Figure 3 - 44 Set date and time

- Enter the **Repeat Interval** using the (+) and (-) buttons on the **Set Interval** submenu to enter the length of time between the start of one recording event and the start of the next event.
- Click the **OK** button when completed to return to the **Time Interval** trigger.



- Click after the **Number of Intervals** entry field and enter the number of times the DAS will record an event (select 0 for infinite).
- Click after the **Record Length** entry field and enter the amount of time that the DAS will record data for each event.
- Click **OK** from the display to accept the update.
- Click **Cancel** to select another type of trigger or change settings.

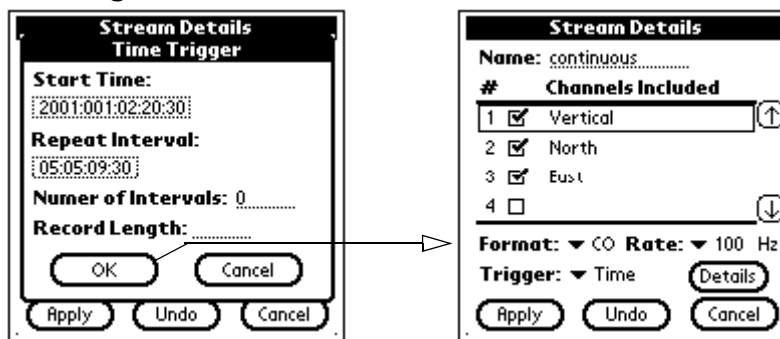

Figure 3 - 45 Time Trigger intervals and record length

12. After the **Stream Details** screen opens click **Apply** (Figure 3 - 46) to approve the stream settings and return to the **Streams** menu to select another datastream

-OR-

Click **Apply** from the **Streams** menu to return to the **Edit Configuration** menu.

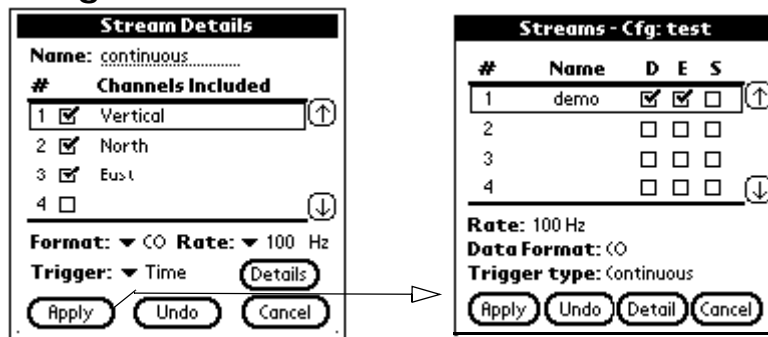

Figure 3 - 46 Completed Stream Details for Time Trigger

3.5.8 Configure a Time List Trigger (TML)

The **Time List** trigger specifies that data will be recorded at each specified time. A Time List trigger event activates when the units internal time matches any one of up to eleven specified times. The DAS terminates the event when the record length is reached. For more information see the *130 Theory of Operations* manual.

Select **Time List** as the trigger type from the pull-down menu:

1. Click **Time List** on the trigger pull-down and the **Time List Trigger** submenu will open.
2. Use the up and down arrows and select a start time from the list.
3. Click the **Edit** button to update the start time.

-OR-

Click the **Clear** button to enter a new start time.

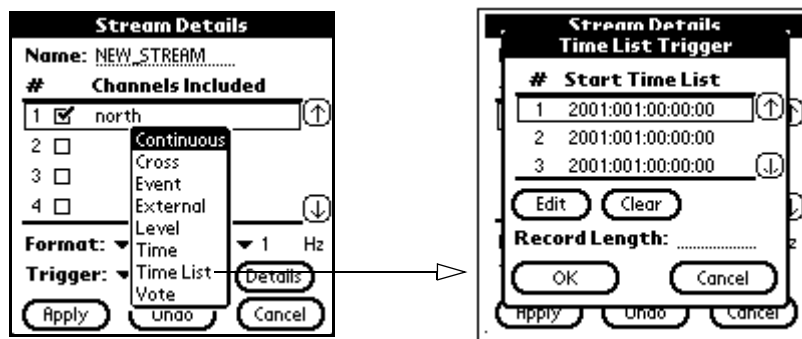

Figure 3 - 47 Time List Trigger submenu

4. Set the date using the **Set Date** submenu on the display.
5. Enter the start time by selecting, with the up and down arrows.
6. Click the **OK** button to approve the start time settings

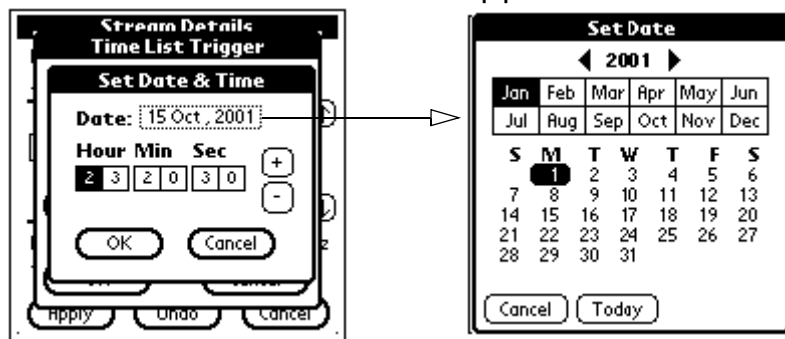

Figure 3 - 48 Set date and time

7. Select the next time list from the **Time List Trigger** display and repeat Steps 5 and 6.
8. After all start times are added, click after the **Record Length** field and enter the amount of time that the DAS will record data for each event.

9. Click **OK** from the display to accept the update.
- OR-
Click **Cancel** to select another type of trigger or change settings.

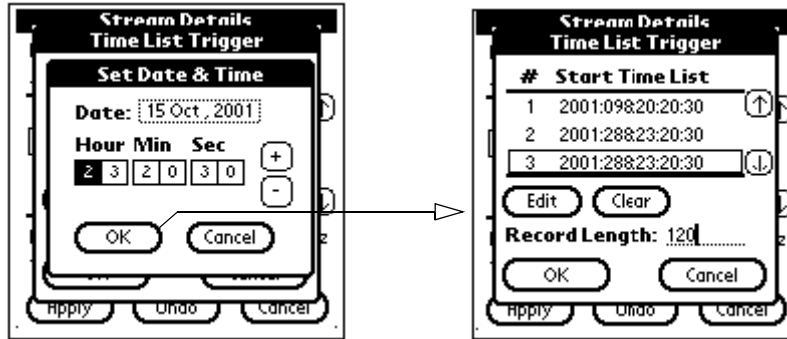

Figure 3 - 49 Set Time and Completed Start Time List

10. After the **Stream Details** screen opens, click **Apply** to approve the stream settings and return to the **Streams** menu to select another datastream,
- OR-
Click **Apply** from this menu to return to the **Edit Configuration** menu.

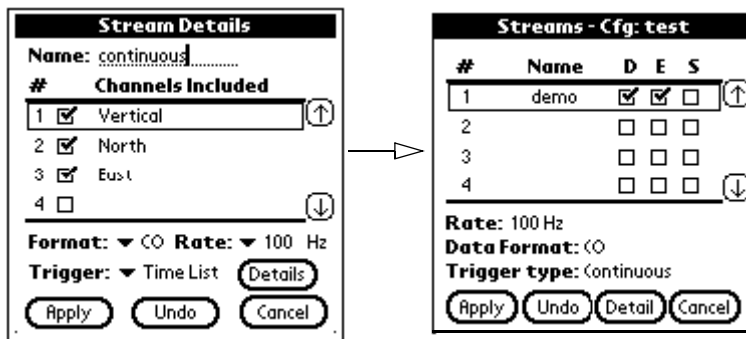

Figure 3 - 50 Time List stream details

3.5.9 Configure a Vote Trigger (VOT)

The **Vote trigger** specifies that data will be recorded when the votes for triggered channels reaches the **Trigger Minimum Votes**. The DAS terminates the event when votes for de-triggered channels reaches the **De-trigger Minimum Votes**. A channel is triggered when it exceeds its individual trigger level. It is de-triggered when it drops below its individual de-trigger level, or below its trigger level when its de-trigger level is not specified. Different levels can be used for triggering and de-triggering a particular channel. For more information see the *130 Theory of Operations* manual (130_theory.pdf).

Select *Vote* as the trigger type from the trigger pull-down menu:

1. Click **Vote** on the trigger pull-down and the **Vote Trigger** submenu will open.
2. Click after the Pre-trigger length parameter field (**Pre:**) and enter the amount of additional data (in seconds) the DAS will record with an event from just prior to the trigger.
3. Click after the Record length parameter field (**Length:**) and enter the minimum amount of data the DAS will record for an event, beginning with the pre-trigger data and including the Post-trigger length.
4. Click after the Post-trigger length field (**Post:**) and enter the amount of additional data the DAS will record with an event from the time of the de-trigger.
5. Click after the Trigger Window field (**Trig. Win:**) and enter the time window seconds in which the number of trigger votes must exceed the minimum votes for the DAS to activate an event
6. Click the **Level Units** drop-down menu and specify the units in G's, % Full Scale or Counts. Whatever units are set here will display in the **Trigger** and **De-Trigger** level submenus.
7. Click after the Trigger Minimum votes field (**Tr. Votes**) and enter the minimum # of votes needed to trigger an event

- Click after the De-trigger Minimum votes field (**De-Tr. Votes**) and enter the minimum # of de-trigger votes needed to de-trigger an event.

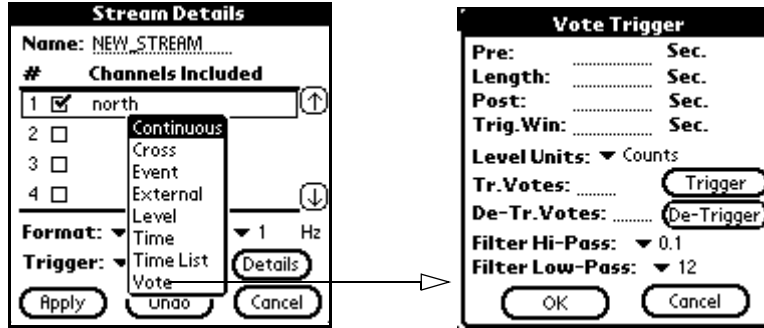

Figure 3 - 51 Vote Trigger submenu

- Select the **Trigger** submenu in order to set trigger thresholds and votes for each channel.
- Select the **Level** field for each channel and enter the level threshold (absolute value) for each channel. The level threshold is the value at which the corresponding channel is considered triggered and its votes are counted.
- Assign the number of votes (**Votes**) to each corresponding channel for detecting a trigger.
- Click the **OK** button to approve the settings

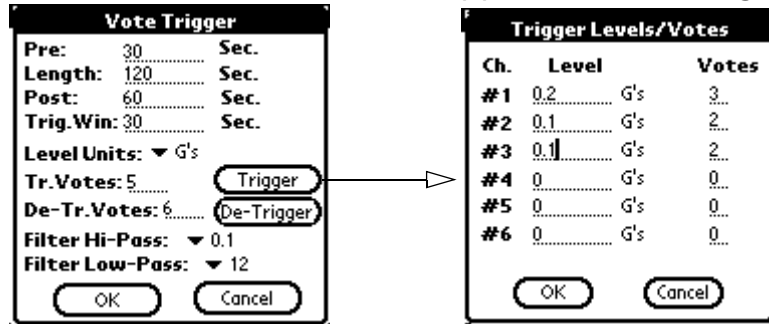

Figure 3 - 52 Trigger Levels/Votes submenu



Note: The Level Units are specified in G's, % F.S., or Count. The Units can be selected on the previous menu screen.

- Select the **De-Trigger** submenu in order to set de-trigger thresholds and votes.
- Select the **Level** field for each channel and enter the level threshold (absolute value) for each channel. The level threshold is the value at which the corresponding channel is considered de-triggered and its votes are counted.
- Assign the number of votes (**Votes**) to each corresponding channel for detecting a de-trigger.

16. Click the **OK** button to approve the settings

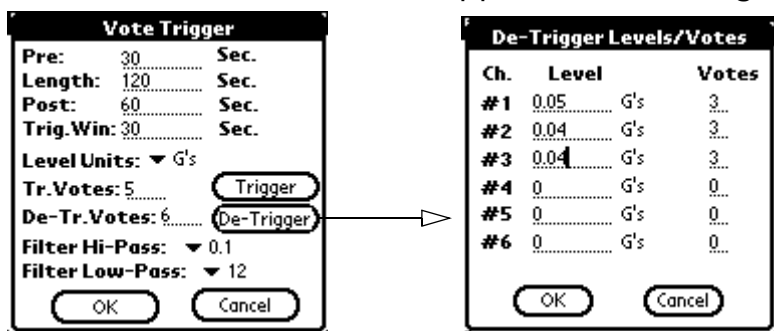

Figure 3 - 53 De-Trigger Levels/Votes submenu

17. Select the **Filter Hi-Pass** drop-down menu and select a Hi-Pass Filter corner frequency (Hz.). This is a 4-pole filter at 0.1 Hz., 2 Hz. or Off (no filtering).

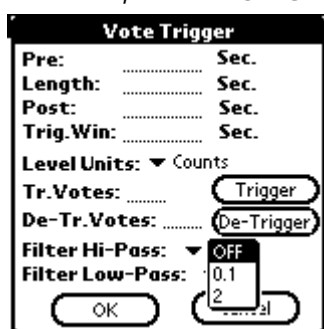

Figure 3 - 54 Set Hi-Pass filter

18. Select the **Filter Low-Pass** drop-down menu and select a Low-Pass Filter corner frequency (Hz.). This is a 4-pole filter at 12 Hz. or Off (no filtering).

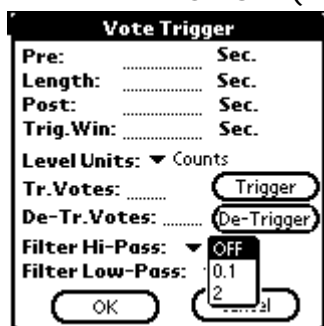
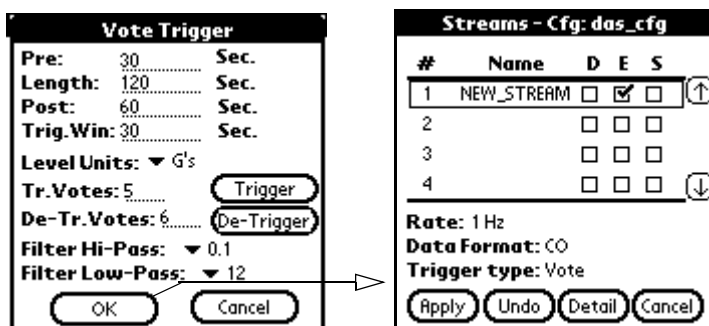

Figure 3 - 55 Set Hi-Pass filter

19. Click **OK** from the menu to return to the **Streams-Cfg** menu.



3.5.10 Deactivate a datastream

If the datastream is active, it shows a check mark in one of destination columns (as shown on the right side of Figure 3 - 56) and a **Detail** button to change the datastream details.

1. To deactivate a datastream select the datastream to be deactivated (see Figure 3 - 56) using the up and down arrow buttons.
2. De-select the **D**, or **E**, and/or **S** check boxes for the datastream that has been selected.

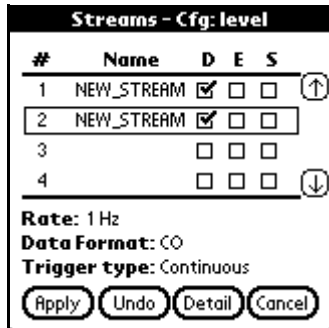

Figure 3 - 56 Deactivate a datastream

3. The display will refresh showing cleared boxes for a datastream, with no name, that was deactivated.
4. To return to the **Configuration Manager** menu click the **Apply** button on the **Streams** menu and **Apply** on the **Edit Configuration** menu.

3.6 130 Auxiliary Data

The auxiliary channels provided on each sensor connector can be used to measure mass position or other auxiliary input data such as temperature and wind speed. Three auxiliary channels are provided for each sensor connector. See the Sensor section on the *130 Theory of Operations* for more information about auxiliary data.

1. Click the **Aux Data** button to setup data collection to the 130 DAS.

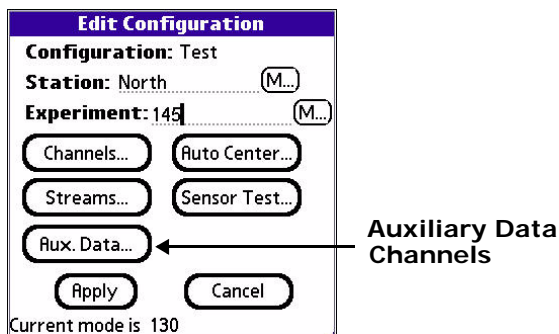
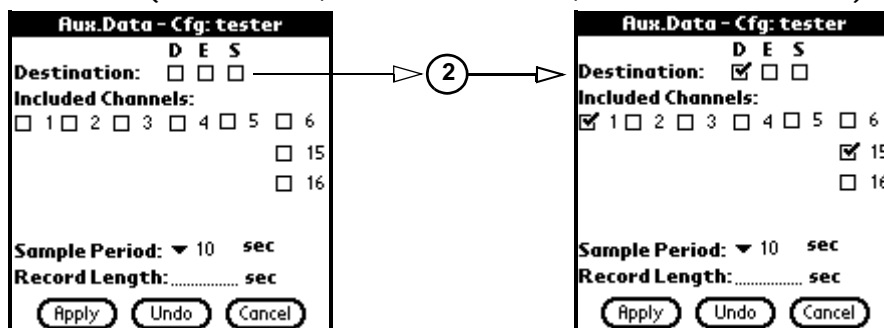

Figure 3 - 57 Auxiliary Data Channels

2. Select the data connection destination options for the data (**D** = Disk, **E** = Ethernet, and **S** = Serial).



Note: The data connection can be set up for Disk and Ethernet or Serial for destination options.

3. Select the channels (used to measure the auxiliary data) to include by taping the channel checkboxes.

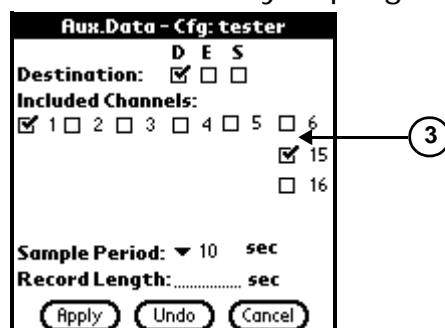

- Click the **Sample Period** pull-down and set the seconds between samples.

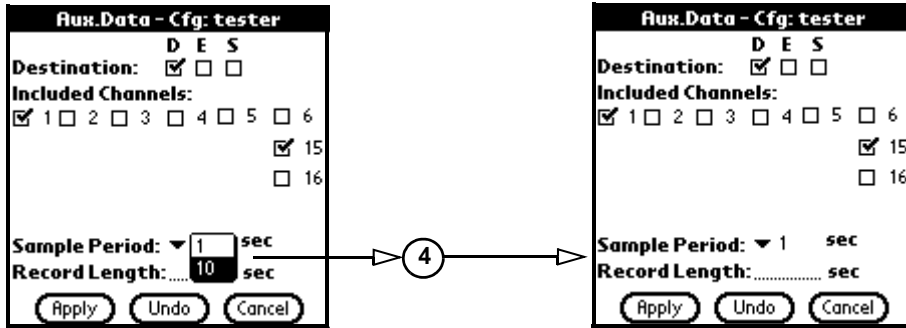

Figure 3 - 58 Aux Data - Sample Period

- Click after the **Record Length** field and enter the total seconds per event record.

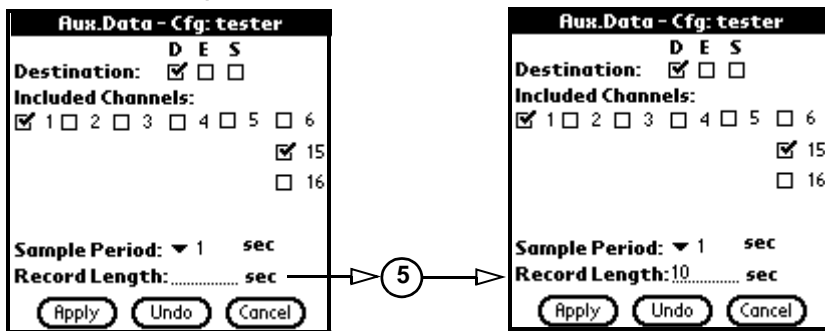

Figure 3 - 59 Aux Data - Record Length

- Click the **Apply** button to accept the settings.



Note: Auxiliary data is recorded as a continuous datastream, at the selected sample period, whenever a recording destination is selected.

Note: If a recording destination is selected then the Auxiliary datastream is considered active.

List of channels

Channel	Description
1-6	RT527 Sensor Control board
15 -	Main Input Voltage
16 -	Temperature

3.7 130-GSN Auxiliary Data

The auxiliary channels provided on each sensor connector can be used to measure mass position or other auxiliary input data such as temperature and wind speed. Three auxiliary channels are provided for each sensor connector. See the Sensor section on the *130 Theory of Operations* for more information about auxiliary data.

1. Click the **Aux Data** button to setup data collection to the 130 DAS.

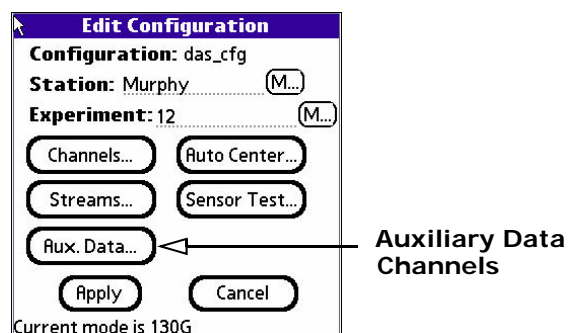

Figure 3 - 60 Auxiliary Data Channels

2. Select the data connection destination options for the data (**D** = Disk, **E** = Ethernet, and **S** = Serial).

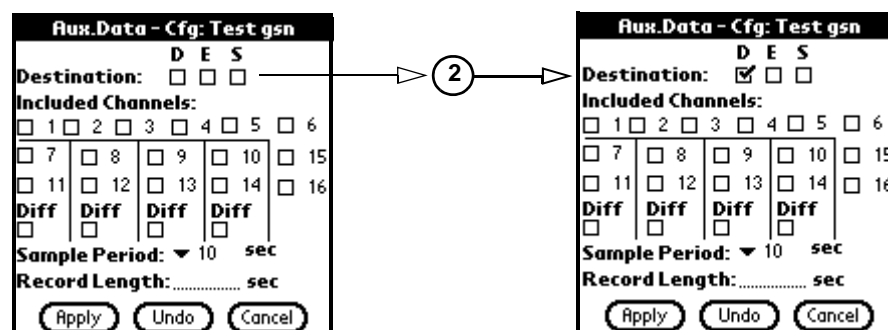

Figure 3 - 61 Aux Data destination



Note: The data connection can be set up for Disk and Ethernet or Serial for destination options.

- Select the channels (used to measure the auxiliary data) to include by taping the channel checkboxes.

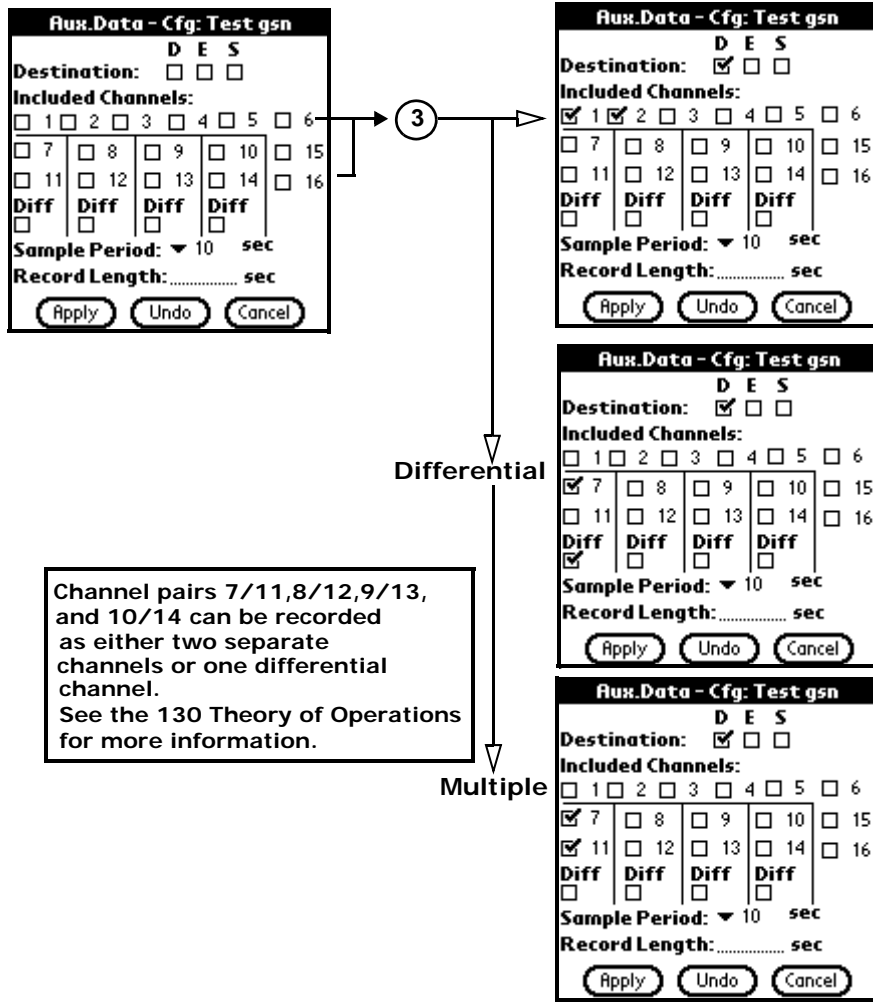

Figure 3 - 62 Aux Data - Differential

- Click the **Sample Period** pull-down and set the seconds between samples.

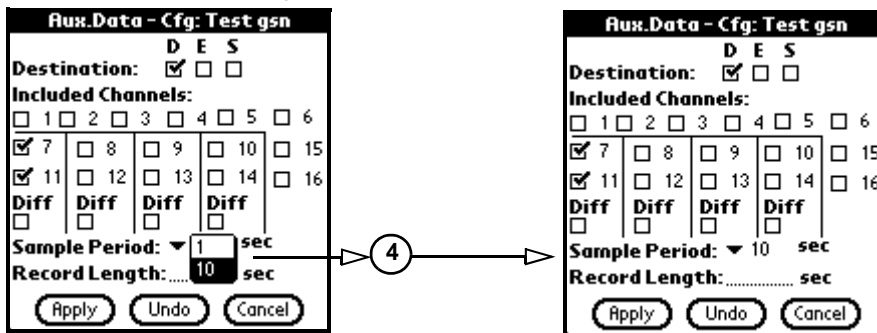

Figure 3 - 63 Aux Data - Sample Period

- Click after the **Record Length** field and enter the total seconds per event record.

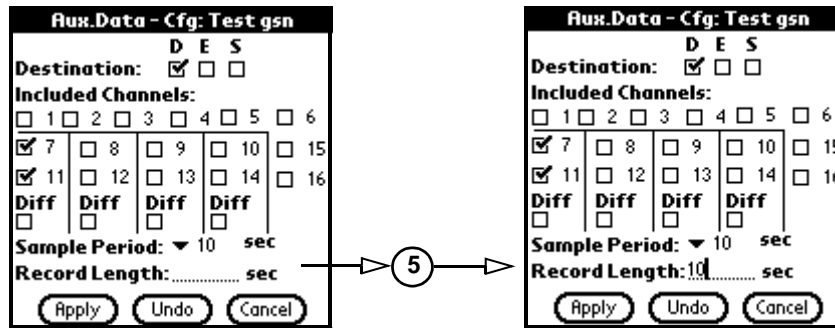

Figure 3 - 64 Aux Data - Record Length3

- Click the **Apply** button to accept the settings.



Note: Auxiliary data is recorded as a continuous datastream, at the selected sample period, whenever a recording destination is selected.

Note: If a recording destination is selected then the Auxiliary datastream is considered active.

List of channels

Channel	Description
1-6	RT527 Sensor Control board
7-14	Optional Aux Data, Board # RT
15 -	Main Input Voltage
16 -	Temperature

3.8 Auto Re-center sensors

1. Click the **Auto Center** button to set auto center parameters for the sensors.
2. Click the **Ch. group** pull-down and select the desired sensor from the pull-down menu.

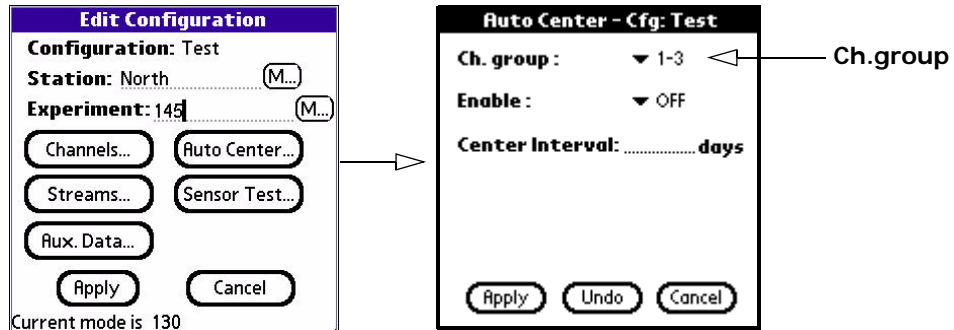

Figure 3 - 65 Auto Center configuration

3. Click Enable **ON** or **OFF** from the pull-down menu.

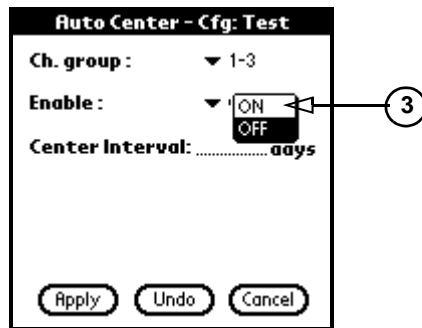
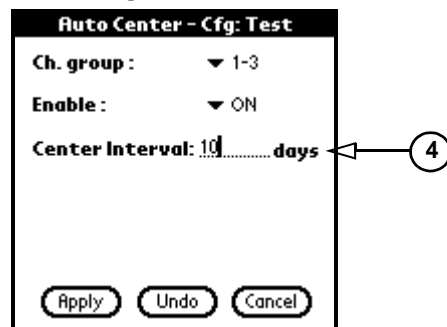

Figure 3 - 66 Auto Center - Enable

4. Enter the **Center Interval** (Interval in days center pulse will be generated).



5. Click the **Apply** button to apply the parameters.

3.9 Sensor Test

See the Sensor section on the *130 Theory of Operations* for more information about calibration.

1. Click the **Sensor Test** button to configure the Sensor test.

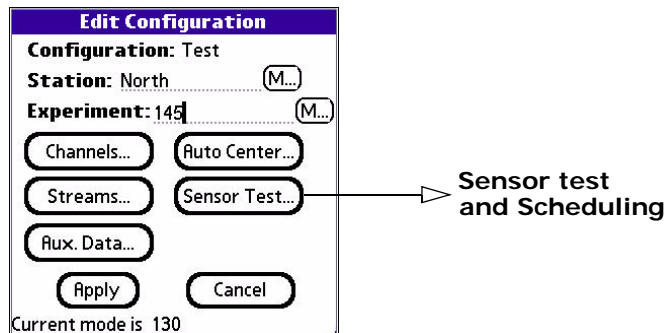

Figure 3 - 67 Sensor calibration signal

2. Select the sensor from the **Ch. group** pull-down.

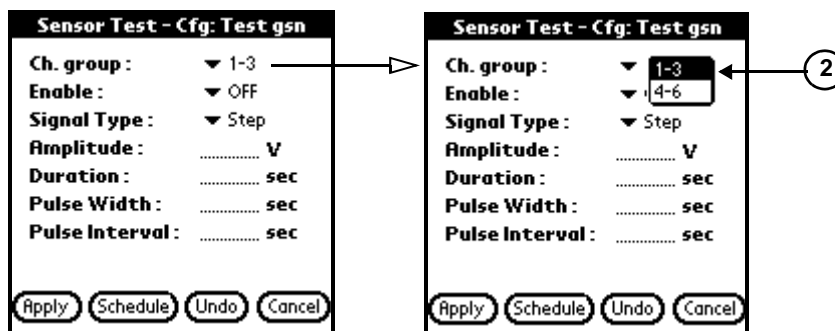

Figure 3 - 68 Sensor Test - Channel group

3. Click the **Enable** (ON-OFF) option from the pull-down to enable or disable the sensor test.

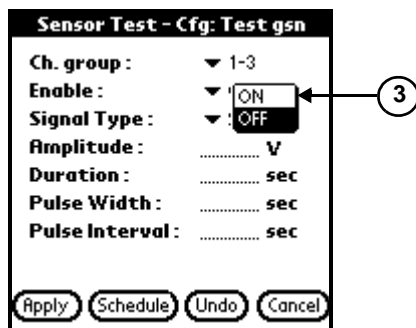

Figure 3 - 69 Sensor test channel and enable

4. Select the **Signal Type** from the pull-down menu where:

Signal	Function
Step	Bi-polar step function. The width specifies the width of each pulse. The interval determines the time from the start of the next pulse. Pulses alternate between positive and negative voltage of the specified amplitude.
Sine	Sine wave centered at 0 volts with a specified peak amplitude and specified frequency.
Random	Pseudo-random noise centered at 0 volts with a specified peak amplitude.
Random-SP	Predefined duration of 60 seconds.
Random-LP	Predefined duration of 300 seconds.
Random-BB	Predefined duration of 3000 seconds.
Sweep-SP	Swept sine wave starting at 50 seconds and going to 100 Hz. Predefined signal type with a duration of 60 seconds.
Sweep-LP	Swept sine wave starting at 2500 seconds and going to 2 Hz. Predefined duration of 3000 seconds.
Sweep-BB	Combination of Sweep-SP and Sweep-LP. This signal type causes the following sequence: <ul style="list-style-type: none"> [1] Run Sweep-SP for 60 seconds (amplitude of ± 1.87 Volts) [2] A 5 minute settling time [3] Run Sweep-LP for 3000 seconds (amplitude of $\pm .05$ Volts) For a total of 56 minutes.

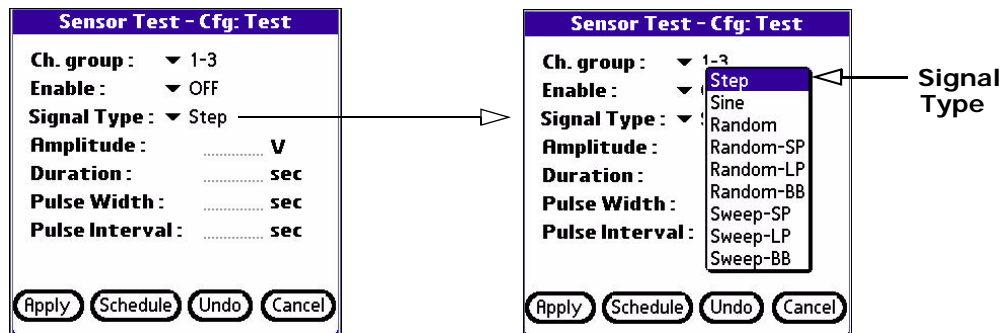

Figure 3 - 70 Signal type pull-down

3.9.1 Step Signal Type

Select a Step signal type from the pull-down menu and:

1. Enter the **Amplitude** (0.01 to 3.75 volts) peak voltage.

Sensor Test - Cfg: Test gsn

Ch. group : ▼ 1-3
 Enable : ▼ ON
 Signal Type : ▼ Step
 Amplitude : V
 Duration : sec
 Pulse Width : sec
 Pulse Interval : sec

Apply Schedule Undo Cancel

Sensor Test - Cfg: Test gsn

Ch. group : ▼ 1-3
 Enable : ▼ ON
 Signal Type : ▼ Step
 Amplitude : 2.5 V
 Duration : sec
 Pulse Width : sec
 Pulse Interval : sec

Apply Schedule Undo Cancel

2. Enter the **Duration** (1-500 seconds) of calibration.

Sensor Test - Cfg: Test gsn

Ch. group : ▼ 1-3
 Enable : ▼ ON
 Signal Type : ▼ Step
 Amplitude : 2 V
 Duration : sec
 Pulse Width : sec
 Pulse Interval : sec

Apply Schedule Undo Cancel

Sensor Test - Cfg: Test gsn

Ch. group : ▼ 1-3
 Enable : ▼ ON
 Signal Type : ▼ Step
 Amplitude : 2 V
 Duration : 250 sec
 Pulse Width : sec
 Pulse Interval : sec

Apply Schedule Undo Cancel

3. Enter the **Pulse Width** of each pulse.

Sensor Test - Cfg: Test gsn

Ch. group : ▼ 1-3
 Enable : ▼ ON
 Signal Type : ▼ Step
 Amplitude : 2 V
 Duration : 25 sec
 Pulse Width : sec
 Pulse Interval : sec

Apply Schedule Undo Cancel

Sensor Test - Cfg: Test gsn

Ch. group : ▼ 1-3
 Enable : ▼ ON
 Signal Type : ▼ Step
 Amplitude : 2 V
 Duration : 25 sec
 Pulse Width : 100 sec
 Pulse Interval : sec

Apply Schedule Undo Cancel

4. Enter the **Pulse Interval** between opposite polarity pulses (determines the time from the start of the next pulse).

Sensor Test - Cfg: Test gsn

Ch. group : ▼ 1-3
 Enable : ▼ ON
 Signal Type : ▼ Step
 Amplitude : 2 V
 Duration : 25 sec
 Pulse Width : 10 sec
 Pulse Interval : sec

Apply Schedule Undo Cancel

Sensor Test - Cfg: Test gsn

Ch. group : ▼ 1-3
 Enable : ▼ ON
 Signal Type : ▼ Step
 Amplitude : 2 V
 Duration : 25 sec
 Pulse Width : 10 sec
 Pulse Interval : 150 sec

Apply Schedule Undo Cancel

5. Click the **Apply** button to accept the updated parameters.

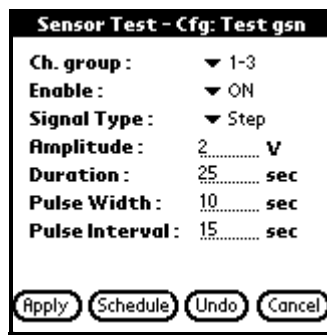

The image shows a dialog box titled "Sensor Test - Cfg: Test gsn". It contains several configuration parameters, each with a dropdown menu or a text input field. The parameters are: "Ch. group" set to "1-3", "Enable" set to "ON", "Signal Type" set to "Step", "Amplitude" set to "2 V", "Duration" set to "25 sec", "Pulse Width" set to "10 sec", and "Pulse Interval" set to "15 sec". At the bottom of the dialog box, there are four buttons: "Apply", "Schedule", "Undo", and "Cancel".

Parameter	Value
Ch. group	1-3
Enable	ON
Signal Type	Step
Amplitude	2 V
Duration	25 sec
Pulse Width	10 sec
Pulse Interval	15 sec

Figure 3 - 71 Sensor Test parameters

3.9.2 Sine Signal Type

Select a Sine signal type from the pull-down menu and:

1. Enter the **Amplitude** (0.01 to 3.75 volts) peak voltage.
2. Enter the **Duration** (1-500 seconds) of calibration.

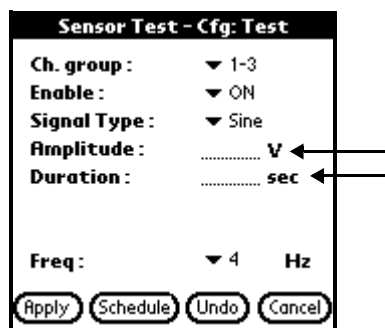
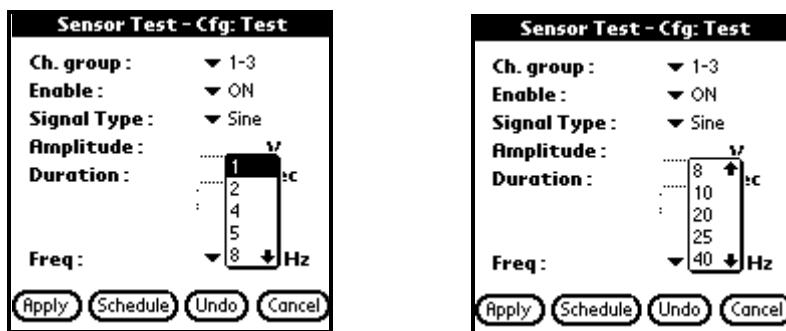

Figure 3 - 72 Sine Signal Type

3. Enter the desired **Frequency** using the pull-down menu.



4. Select the **Apply** button to apply the settings.

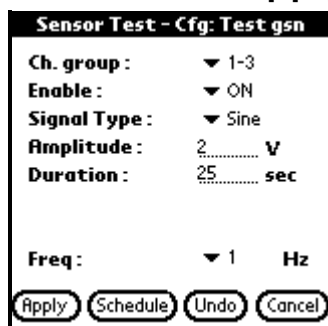

Figure 3 - 73 Sine Signal Frequency

3.9.3 Random Signal Type

Select a **Random** signal type from the pull-down menu and:

1. Enter the **Amplitude** (0.01 to 3.75 volts) peak voltage.
2. Enter the **Duration** (1-500 seconds) of calibration.

The figure shows two instances of the 'Sensor Test - Cfg: Test' dialog box. Both have the following settings: Ch. group: 1-3, Enable: ON, Signal Type: Random. The left instance has empty input fields for Amplitude and Duration, with an arrow labeled 'Amplitude' pointing to the Amplitude field. The right instance has empty input fields for Amplitude and Duration, with an arrow labeled 'Duration' pointing to the Duration field. Both instances have 'Apply', 'Schedule', 'Undo', and 'Cancel' buttons at the bottom.

3. Select the **Apply** button to approve the settings.

The figure shows the 'Sensor Test - Cfg: Test gsn' dialog box with the following settings: Ch. group: 1-3, Enable: ON, Signal Type: Random, Amplitude: 2.0 V, and Duration: 25 sec. The 'Apply', 'Schedule', 'Undo', and 'Cancel' buttons are visible at the bottom.

Figure 3 - 74 Random Signal Type

3.9.4 Random-SP Signal Type

Select a Random-SP signal type from the pull-down menu and:

1. Enter **Random-SP** as the Signal Type
2. Enter the **Amplitude** (0.01 to 3.75 volts) peak voltage.
Duration of 60 seconds of calibration is predefined.

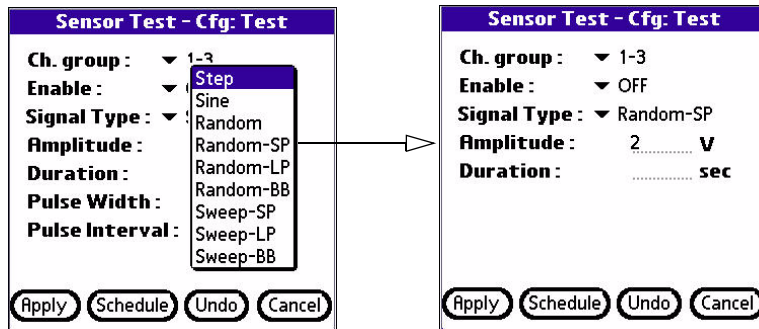

Figure 3 - 75 Random-SP Signal Type

3. Select **Apply** to accept the test.

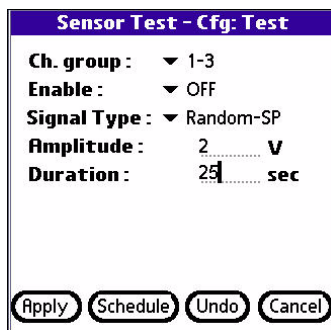
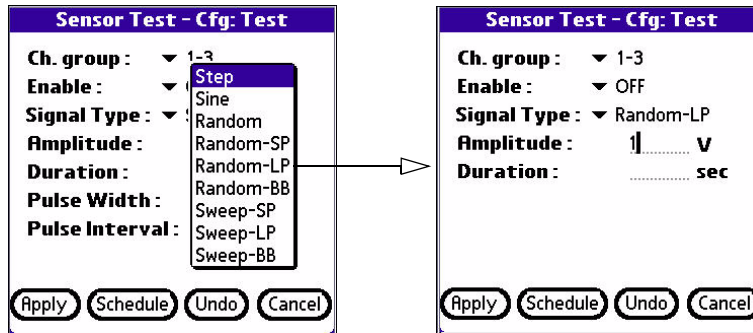

Figure 3 - 76 Random-SP Duration

For the Random-LP signal type:

1. Enter **Random-LP** as the Signal Type.
2. Enter the **Amplitude** (0.01 to 3.75 volts) peak voltage.
Duration of 300 seconds of calibration is predefined.

**Figure 3 - 77 Random-LP Signal Type**

3. Select **Apply** to accept the test.

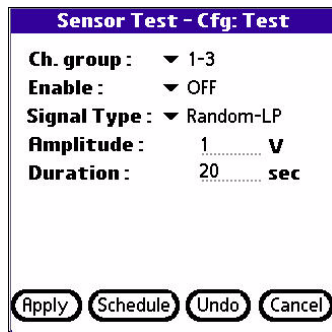
**Figure 3 - 78 Random-LP Duration**

For the Random-BB signal type:

1. Enter **Random-BB** as the Signal Type
2. Enter the **Amplitude** (0.01 to 3.75 volts) peak voltage.
Duration of 3000 seconds of calibration is predefined.

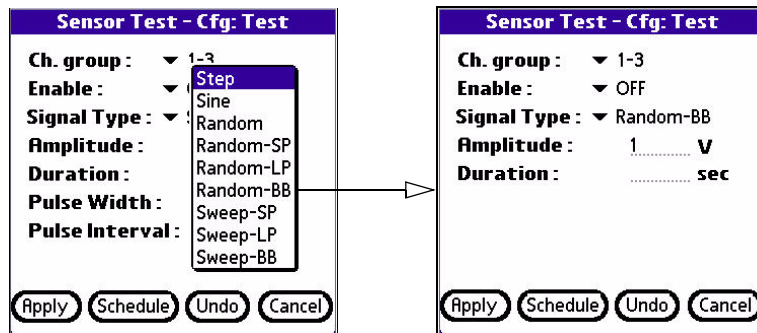

Figure 3 - 79 Random-BB Signal Type

3. Select **Apply** to accept the test.

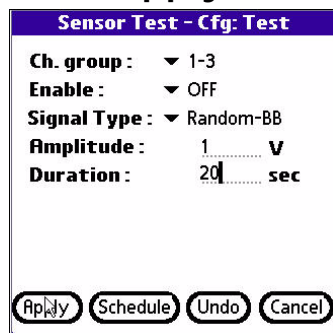

Figure 3 - 80 Random-BB Duration

For the Sweep-SP signal type:

1. Enter **Sweep-SP** as the Signal Type.
2. Enter the **Amplitude** (0.01 to 3.75 volts) peak voltage.

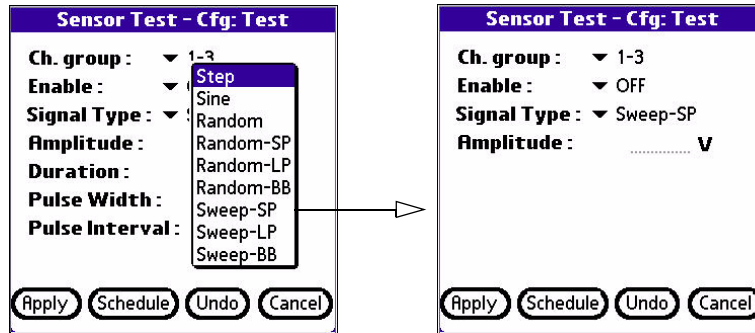

Figure 3 - 81 Sweep-SP Signal Type



Note: Swept sine wave starting at 50 seconds and going to 100 Hz.

Note: Sweep-SP is a predefined signal type with a duration of 60 seconds.

3. Select **Apply** to accept the test.

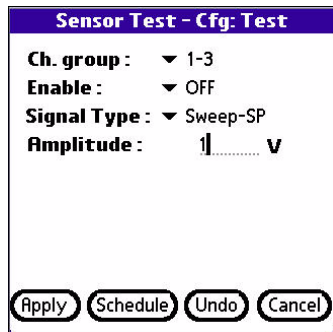

Figure 3 - 82 Sweep-SP

For the Sweep-LP signal type:

1. Enter **Sweep-LP** as the Signal Type.
2. Enter the **Amplitude** (0.01 to 3.75 volts) peak voltage.

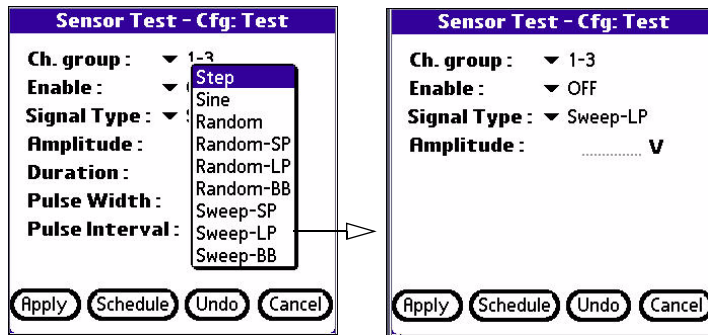

Figure 3 - 83 Sweep-LP Signal Type



Note: Predefined signal type with a duration of 3000 seconds.

Note: Swept sine wave starting at 2500 seconds and going to 2 Hz.

3. Select **Apply** to accept the test.

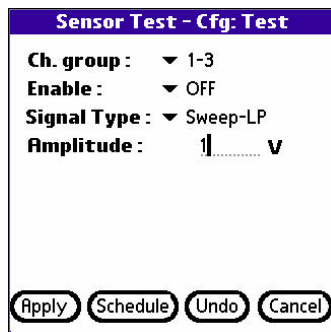

Figure 3 - 84 Sweep-LP

For the Sweep-BB signal type:

1. Enter **Sweep-BB** as the Signal Type.
2. Enter the **Amplitude** (0.01 to 3.75 volts) peak voltage.

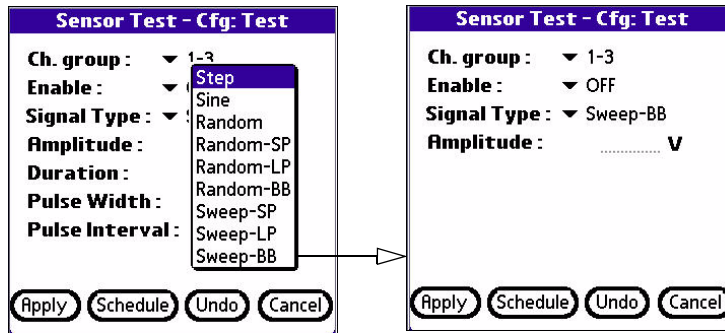

Figure 3 - 85 Sweep-BB Signal Type



Note: Combination of Sweep-SP and Sweep-LP. This signal type causes the following sequence:

- [1] Run Sweep-SP for 60 seconds (amplitude of ± 1.87 Volts)
- [2] A 5 minute settling time
- [3] Run Sweep-LP for 3000 seconds (amplitude of $\pm .05$ Volts)

Note: For a total of 56 minutes.

3. Select **Apply** to accept the test.

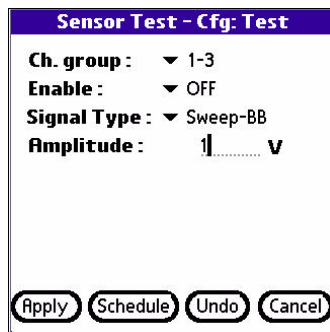

Figure 3 - 86 Sweep-BB Amplitude

3.9.5 To schedule sensor tests

Sensor tests can be scheduled using the **Schedule** button on the **Sensor Test** display. One schedule can be setup for each channel group (**Ch. group 1-3**)(**Ch. group 4-6**).

1. Select the **Schedule** button to open the schedule display and setup schedule times.

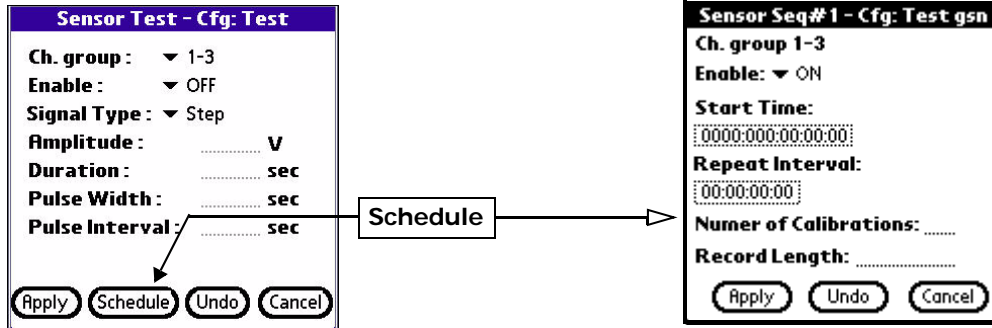

Figure 3 - 87 Schedule button

2. Use the **Enable** drop-down menu to turn scheduling **ON** or **OFF**.



3. Select the **Start Time** window to set a date for the calibration to start



Note: The schedule for channels 1-3 and the schedule for channels 4-6 CANNOT overlap in time.

4. Approve the Date and Time by selecting the **OK** button.

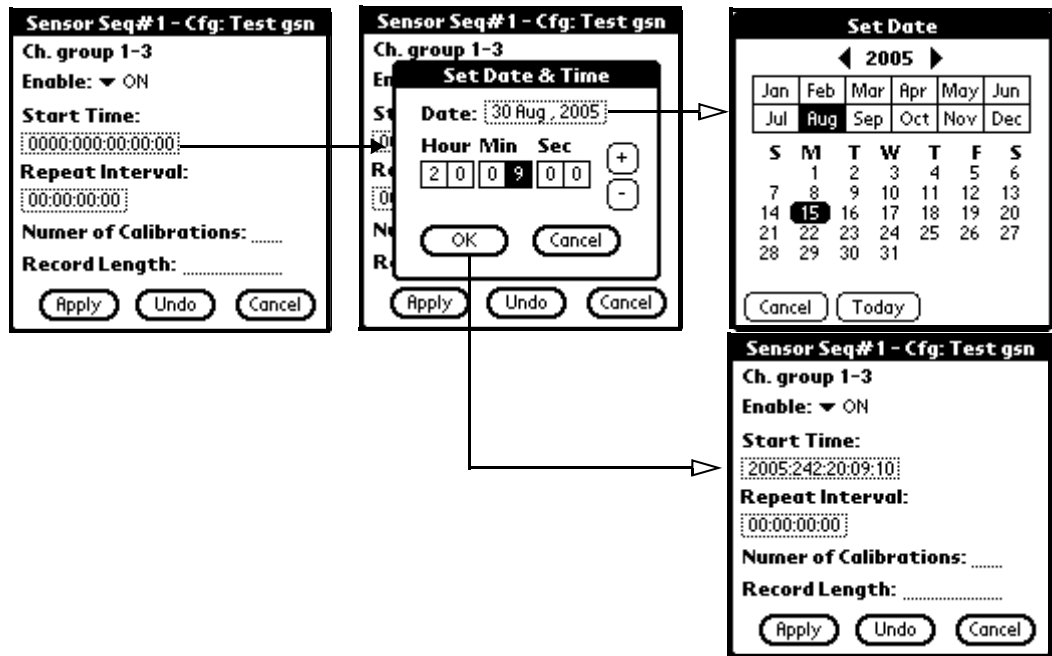

Figure 3 - 88 Set Schedule Start Time

5. Select the **Repeat Interval** window to set the time to repeat the calibration.

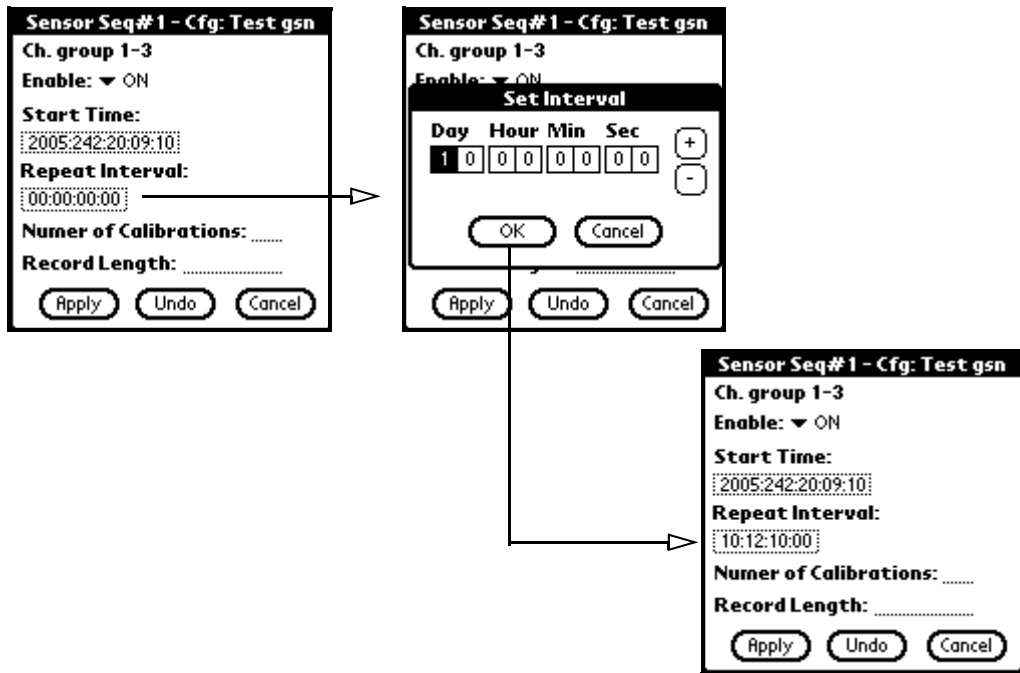
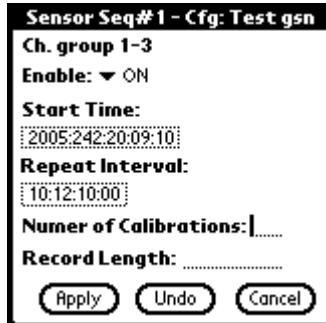

Figure 3 - 89 Set Calibration Repeat Interval

6. Tap beside the **Number of Calibrations** field to enter how many times to repeat the set calibration.



Sensor Seq#1 - Cfg: Test gsn

Ch. group 1-3

Enable: ▼ ON

Start Time: 2005:242:20:09:10

Repeat Interval: 10:12:10:00

Numer of Calibrations: |.....

Record Length:

Apply Undo Cancel

7. Tap beside the **Record Length** field to enter the desired record length.



Sensor Seq#1 - Cfg: Test gsn

Ch. group 1-3

Enable: ▼ ON

Start Time: 2005:242:20:09:10

Repeat Interval: 10:12:10:00

Numer of Calibrations: 3.....

Record Length: |.....

Apply Undo Cancel

8. Approve the schedule by selecting the **Apply** button.



Sensor Seq#1 - Cfg: Test gsn

Ch. group 1-3

Enable: ▼ ON

Start Time: 2005:242:20:09:10

Repeat Interval: 10:12:10:00

Numer of Calibrations: 3.....

Record Length: 10.....

Apply Undo Cancel

Figure 3 - 90 Number of Calibrations

3.10 Save or delete configurations

1. Save the configuration by clicking **Apply** on the **Edit Configuration** display and the **Configuration Manager** display will open.
2. Click the **Save** button to save the configuration.
3. Click the OK on the **PFC_130** display to approve the save.

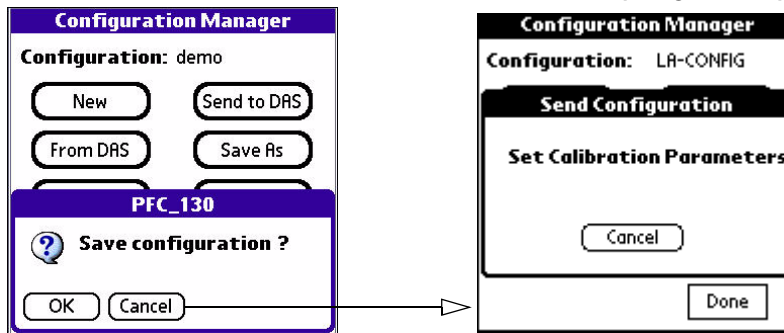

Figure 3 - 91 Save configuration

Save a configuration as:

1. Click the **Save As** button to check what other configurations are saved or save the new configuration to another name.
2. Click the **OK** button to approve the save operation.

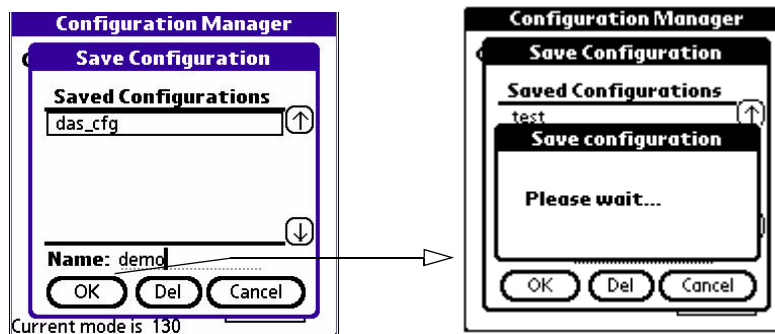
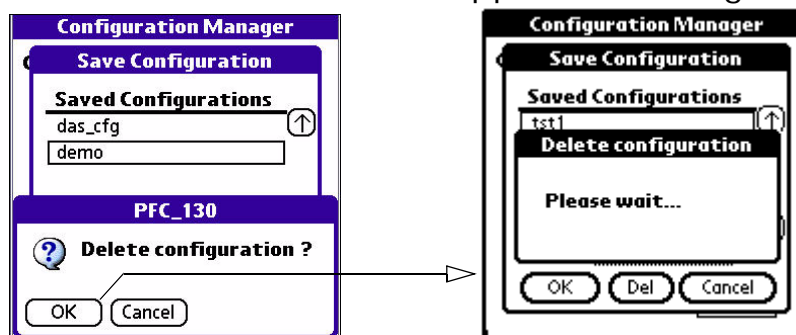

Figure 3 - 92 Saved As - configuration

Delete a configuration:

1. Click the **Delete** button to delete a saved configuration
2. Click the **OK** button to approve deleting the configuration.



3.11 Load a saved configuration

To load a saved or different configuration:

1. From the **Configuration Manager** click the **Load** button.
2. Select the name of the configuration file to load (from the list).
3. Click the **OK** button.

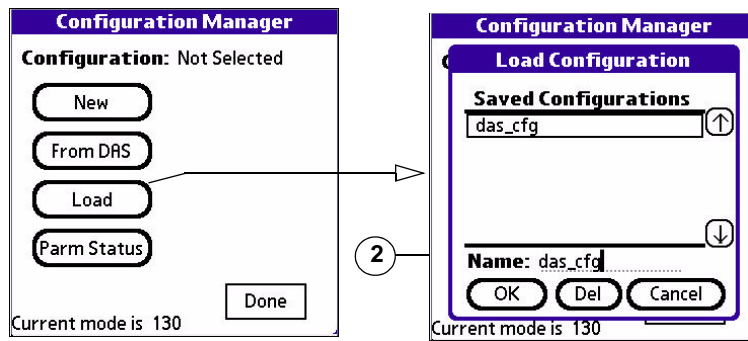
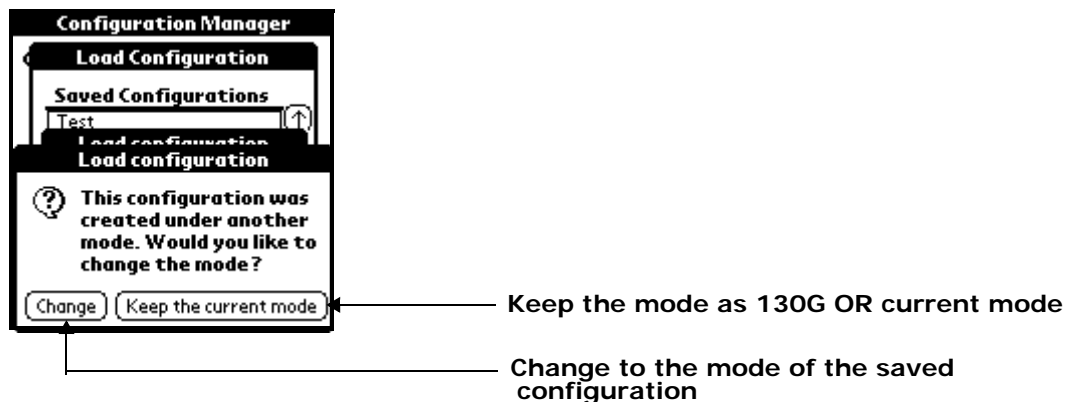

Figure 3 - 93 Load a saved configuration

WARNING: When loading a saved configuration be sure the mode of the configuration is the same or the following warning screen will open.



4. The configuration name appears on the **Configuration Manager** display.

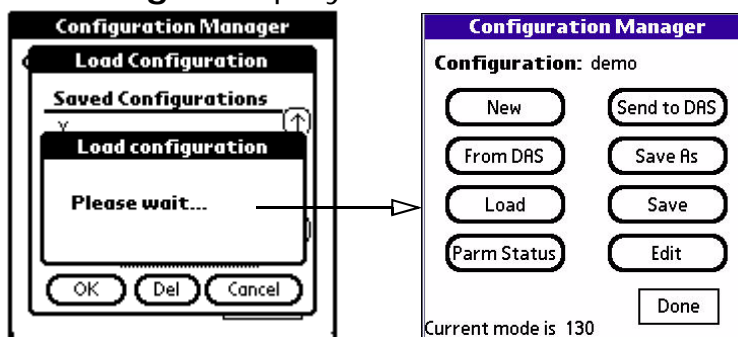

Figure 3 - 94 Loading a saved configuration

3.12 Check parameter status

To check active channels and active streams:

1. Click the **Param Status** button.
2. Click the **Update** button to update status data.

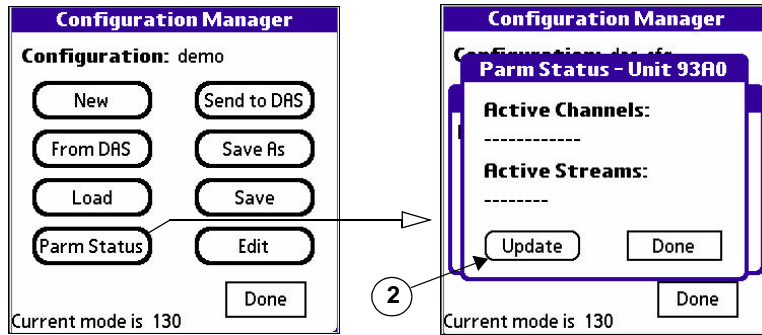

Figure 3 - 95 Param Status button

3.13 Send a configuration to the DAS

To send a configuration to the DAS:

1. Click the **Send to DAS** button.
2. Click the **OK** button to accept the send operation.

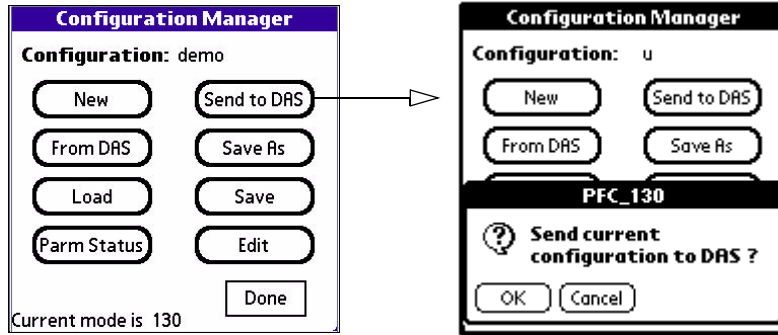

Figure 3 - 96 Send a configuration to the DAS

3.14 From DAS

To query the DAS for the current configuration:

1. Click the **From DAS** button.
2. The current parameter set is read from the DAS and stored in the PDA for editing or checking.
3. The Configuration Manager screen returns with the configuration changed to show "das_cfg".



Figure 3 - 97 Get configuration from DAS

3.15 Appendix A: Software installation



Note: Before upgrade of the PFC_130 application, click the Menu icon on the PDA device, select the App pull-down, and the Delete icon. Click the PFC_130 and delete. Also click the database file PFC_CFG_DB and delete it.



Note: To obtain software updates for the PFC_130:

- [1] Use Internet Explorer and enter: www.reftek.com/downloads.html
- [2] Username: Anonymous
- [3] Password: Your E-Mail address

These instructions assumes the **Ruggedized** PDA device has never been used and the PDA software has not been installed on a PC, or the battery has been removed the battery for more than one minute and all of the **REF TEK** installed application programs have been erased.

1. Configure the PDA device according to the instructions included in the PDA kit.
2. Load the enclosed PDA CD. The PDA software will ask for a username during installation (Ref Tek is the username given when initially configured).
3. Copy the REF TEK applications (PFC_130. prc) into the c:\palm\Add-On directory.
4. Click on the desktop icon labeled for the PDA Desktop.
5. Select the HotSync/Custom menu.

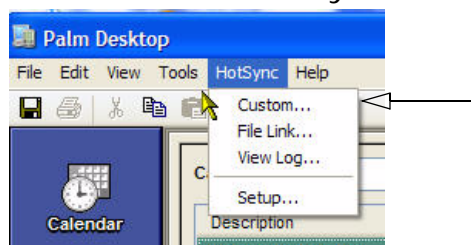

Figure 3 - 98 Hotsync menu

6. Disable all conduits except Install, Install Templates and Install to Card.
7. To change the action of a conduit: Highlight the conduit. Click Change. Select the desired action (select Do Nothing to Deactivate). Click OK.

8. Select the **Done** button when the conduit changes are complete.

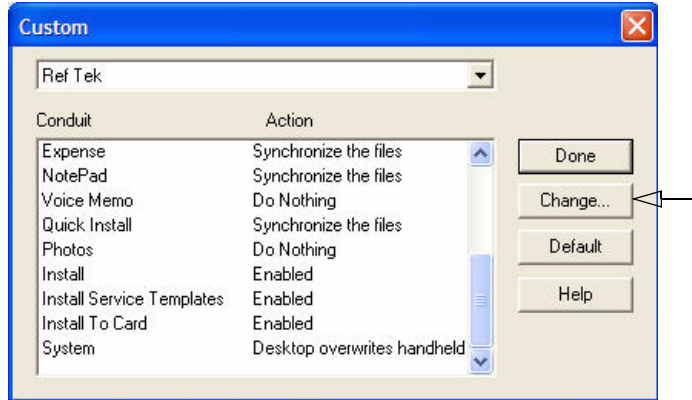

Figure 3 - 99 Custom HotSync options

9. Select the HotSync menu button on the PDA screen. Allow the synchronization process to complete. (Note: The first sync may take several minutes.) Once the HotSync has been completed note the devices name in the upper right corner of the display window (i.e., PalmTree1, PalmTree2, etc.).
10. Click the Quick **Install** or Install icon on the left side of the PDA Desktop window.

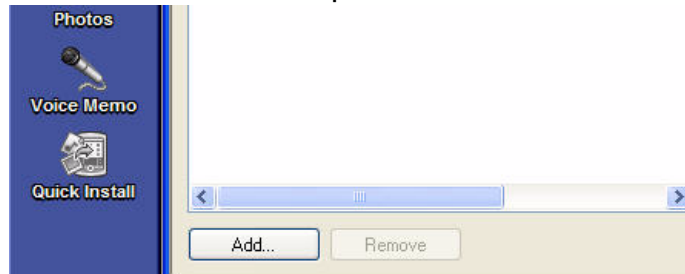

Figure 3 - 100 Install PFC

11. Then select the **Add** button and select all the **REF TEK** files. Click **Open**, then **Done** and **OK** to add the files.

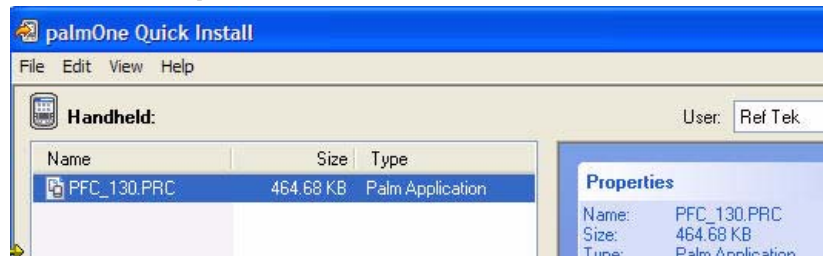

Figure 3 - 101 PFC file added

12. Close the open install window and approve with the **OK** button.

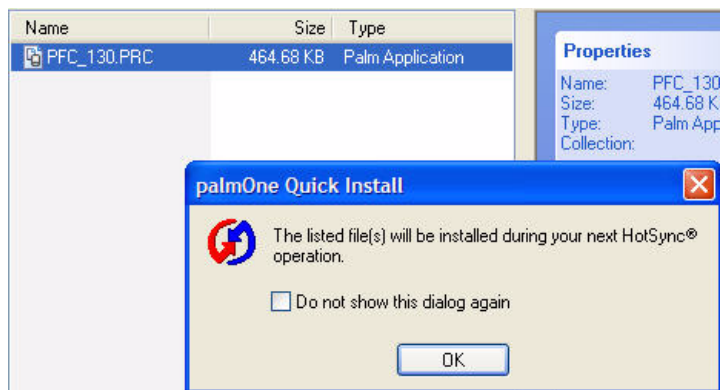

Figure 3 - 102 Approve installation during HotSync

13. Perform a second HotSync by selecting the HotSync menu. The REF TEK program files will be transmitted to the PDA device.



Figure 3 - 103 HotSync process

Follow these steps to configure the PDA

Step:	Description:
(1) Add a REF TEK program category	Select the Home icon on the PDA. All installed programs will be displayed. Select the Category menu (top right corner) and select Edit Categories . Select New , enter REF TEK for the category name and select OK . Select OK again to end editing categories
(2) Move the programs to the REF TEK category	Select the Menu icon and select App/Category. Change the category for PFC_130 by selecting the list arrow next to each program name and selecting REF TEK (use the scroll bar to the right to view all programs). Select Done when complete.
(3) Move to the REF TEK category	Select the Category menu and select REF TEK. At this point one program should be displayed (PFC_130). The PFC_130 application will be used to communicate with the DAS and is used to create or edit DAS parameters.
(4) If using a Ruggedized PDA, make a card backup of the PFC_130 file	<p>[1] Select the CardBkp icon on the PDA to backup a copy of the PFC_130 program.</p> <p>[2] Select the Setup icon to select the files to be copied to the backup card.</p> <p>[3] Select the Backup Exclusion List option and use the check boxes to select files that DO NOT need to be copied to the backup card (i.e. if PFC_130 were the only unchecked box it would be copied to the backup card).</p> <p>[4] Select the Save icon to save the selections.</p> <p>[5] Select the Done icon to exit the screen.</p> <p>[6] Select the Backup Now option to copy and backup the PFC_130 program to the backup card.</p>
(5) To restore the PFC_130 program from the backup card.	To restore the PFC_130 program use the Restore icon from the Card Backup option screen. A Partial restore can be done to restore just the PFC_130 program if desired.

Index

A

- activate a channel with the PDA 3-43
- activate datastreams 3-48
- adding 130-channel comments 3-44
- adding datastream details 3-49
- assign Serial PPP baud rate 2-21
- assign Serial PPP line mode 2-21
- auto center sensor 3-77
- Aux Channels mass position 2-32
- Aux Cntrl
 - ANSS Sensor Test 2-28
 - Aux Channel - data 2-28
 - Offset 2-28, 2-29
 - Test 1-3 test signal 2-28
 - Test 4-6 test signal 2-28
- auxiliary data 3-72, 3-74

C

- checking the station status 2-8
- CON continuous trigger 3-52
- configuration of the PDA 3-39
- connection
 - setup - Net information 2-17
- cross trigger
 - PDA submenu 3-57
- CRS - cross trigger 3-57

D

- data collection 3-72, 3-74
- data recording w/ Aux Data 2-32
- deactivate
 - channel 3-47
 - datastream 3-71
- define a data stream 3-48
- direct - Line Mode (PDA) 2-21
- disk
 - format (PDA) 2-36

E

- edit PDA configuration 3-42
- ethernet
 - control option 2-18
 - line down options (PDA) 2-19
 - parameters (PDA) 2-17
 - send parameters (PDA) 2-19
- Event Trigger
 - PDA submenu 3-59
- EVT- Event Trigger on PDA 3-59
- External Trigger
 - PDA submenu 3-62
- EXT-External Trigger 3-62

F

- format disk menu 2-36
- FW Multi option 2-21

G

- generate sensor test signal 2-31
- GPS
 - Asleep 2-10
 - check status of 2-10
 - Continuous or Cycle 2-10
 - Locked 2-10
 - Searching 2-10
 - update status of 2-10

I

- instructions to load PDA software 10-v, 3-98
- internal ANSS sensor test 2-31

K

- Keep - Line Down parameter PDA 2-18
- Keep parameter 2-20

L

- Level Trigger
 - PDA submenu 3-54
- Line Down - Keep and Toss PDA 2-20
- Line Down option (PDA) 2-18

M

- mass position 2-32
- measured offset 2-30
- Monitor - display monitor command 2-26

N

- new offset 2-30
- new PDA configuration 3-41

O

- Offset
 - calculation 2-30
 - option 2-29

P

- PFC_130
 - 130 cannot connect 2-37
 - acquisition on or off 2-9
 - activate a channel 3-43
 - add
 - channel details 3-44
 - station comments 3-42
 - stream details 3-49
 - stream name 3-49
 - Configuration Manager 3-39
 - connection, initialize 2-7
 - Continuous Trigger submenu 3-52
 - Cross Trigger submenu 3-57
 - deactivate
 - a channel 3-47
 - datastream 3-71
 - define data stream 3-48
 - edit configuration 3-42
 - enter experiment name 3-42
 - equipment supplied 1-2
 - Event Trigger setup 3-59
 - External Trigger setup 3-62
 - format disk 2-36
 - Level Trigger setup 3-54
 - online control menu 2-7
 - PDA setup 1-3
 - Save As (configuration) 3-93
 - Save configuration 3-42
 - select type of trigger 3-51
 - set
 - data format 3-49
 - Gain 3-45
 - IP address 2-17
 - new parameters 3-41
 - sample rate (Hz) 3-51
 - start application 1-3

- starting application 1-4
- Status menu 2-8
- switch between applications 1-3
- Time List Trigger setup 3-66
- verify PDA connection 2-38
- Vote Trigger setup 3-68

R

- record offset 2-29

S

- sample rate groups 3-50
- sensor information screen 2-15
- sensor test 3-78
- sensor test option 2-31
- Serial PPP
 - assign parameters 2-20
 - direct connection 2-21
 - FW Multi Freewave 2-21
- setting a data stream format 3-49
- setting the 130-ANSS/02 triggers 3-51
- Start Acq 2-9
- Status menu

- on Control Unit screen 2-8
- using the Palm 2-8
- store offset 2-30
- Stored offset 2-30

T

- time list trigger palm submenu 3-66, 3-69
- time trigger palm submenu 3-63
- TIM-time trigger 3-63
- TML-time list trigger 3-66, 3-68
- Toss parameter 2-18, 2-20
- trigger
 - continuous trigger (CON) 3-52
 - cross trigger (CRS) 3-57
 - Event Trigger PDA setup (EVT) 3-59
 - External Trigger (EXT) 3-62
 - Level Trigger on PDA (LEV) 3-54
 - time list trigger (TML) 3-66, 3-68
 - time trigger (TIM) 3-63
 - Vote Trigger (VOT) 3-68

V

- Vote trigger (VOT) 3-68